

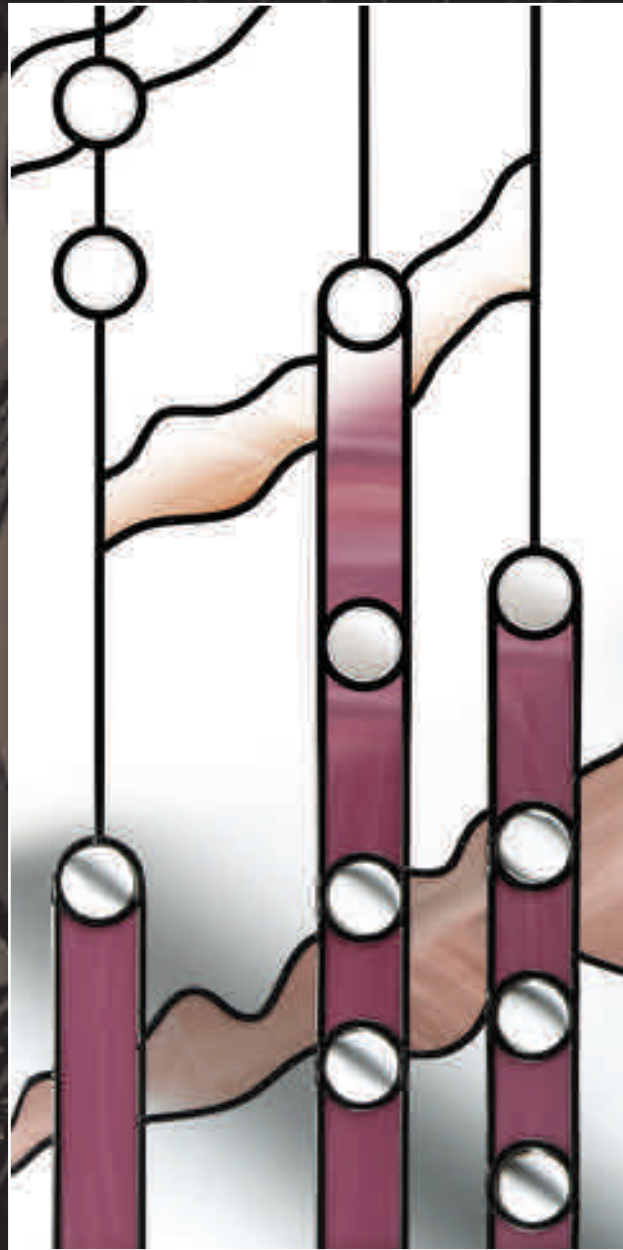

Vidrio Diseñado



opciones creativas para
gabinetes
y muebles

Diseños de vidrio con plomo • diseños de vidrio de revestimiento
diseños de vidrio biselado • diseños de vidrio de fusión

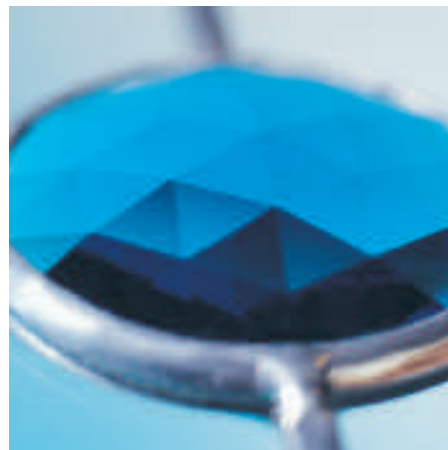
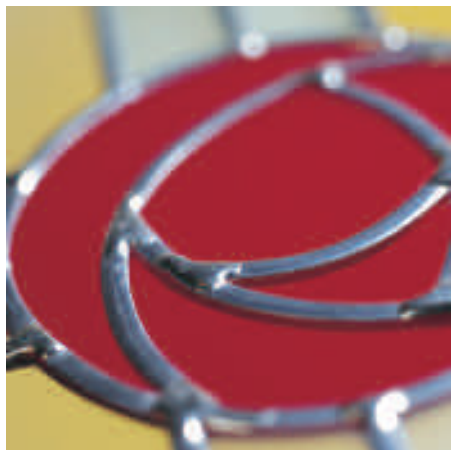

Indice

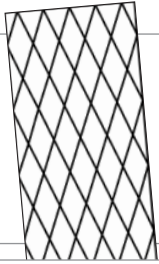

Diseños Sencillos
con Plomo
SECTION 1

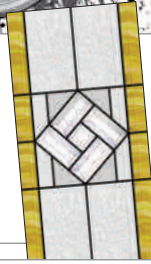

Diseños Biselados
Sencillos
SECTION 9

Estilo Mackintosh
SECTION 2

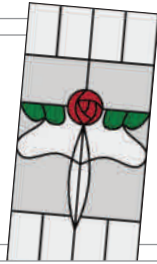

Colección de
Diseñadores
SECTION 10

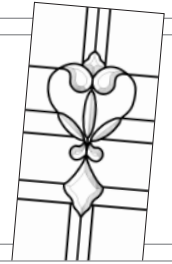

Contemporáneos
SECTION 3

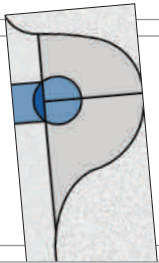

Agrupaciones de
Biselados
SECTION 11

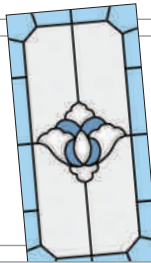

Inspirados por el
Suroeste / la Pradería
SECTION 4

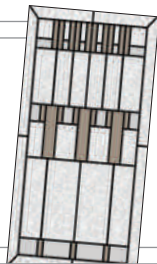

Biselados de Rincón
SECTION 12

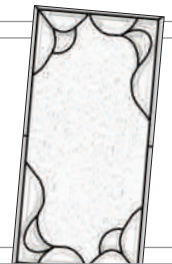

Flores
SECTION 5

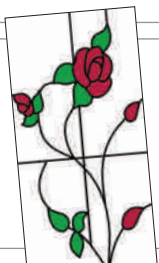

Joyas
SECTION 13

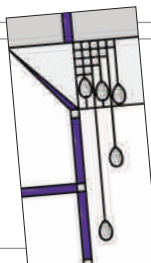

Tradicionales
SECTION 6

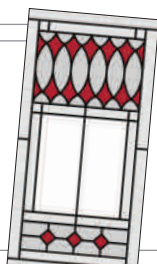

Fusión
SECTION 14



Para la Cocina
SECTION 7

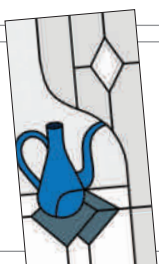

Fusión Ligera
SECTION 15

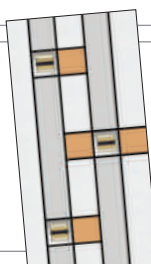

Grabados y con Plomo
SECTION 8



Efectos de
Textura de Vidrio
SECTION 16





Diseños Sencillos con Plomo



CABLD 16

En las 5 páginas siguientes, mostramos 30 diseños con plomo sencillos y clásicos apropiadas para la mayoría de los gabinetes de cocina y de mueblería – de los tradicionales a los modernos.

Para todos estos diseños, recomendaríamos el uso de perfiles de plomo de 4.5mm ($\frac{3}{16}$ ") están disponibles en una variedad de colores (Anticuario, Latón, Natural y Blanco).

Con estos diseños sencillos, se pueden aplicar los perfiles de plomo por encima de algunos tipos de texturas de vidrio o se puede incorporar alguna de las películas de Efecto de Textura de Vidrio que ofrecemos (se muestran en las páginas 52-53)



Anticuario



Latón

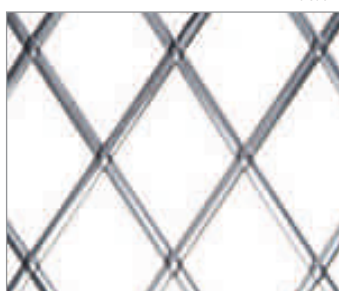

Natural



Blanco

Diseños Sencillos con Plomo



CABLD 01

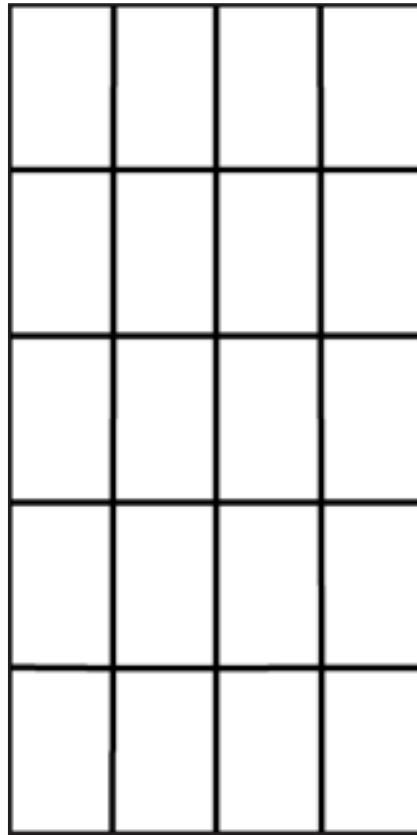

CABLD 02

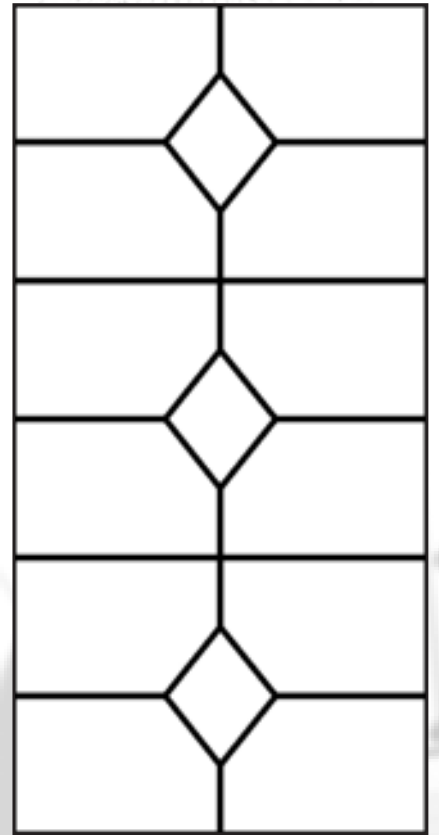

CABLD 03

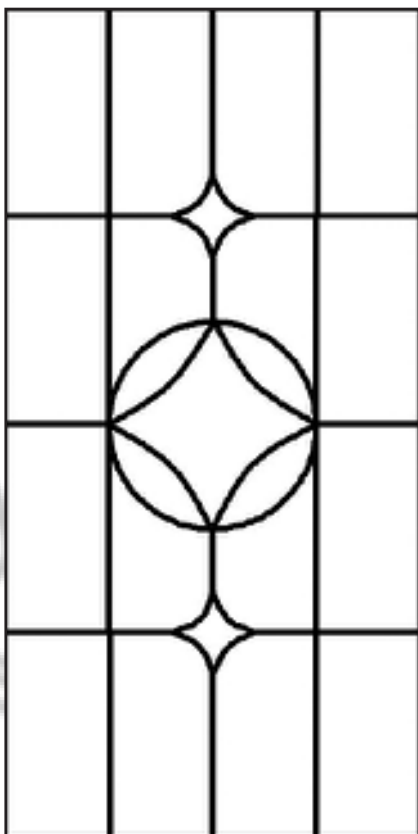

CABLD 04

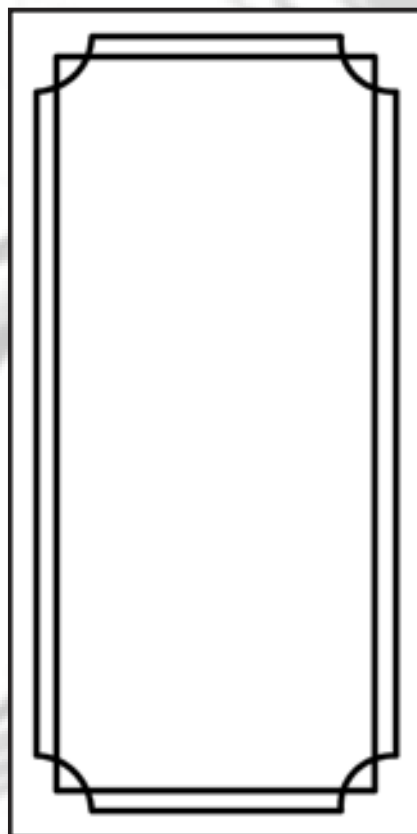

CABLD 05

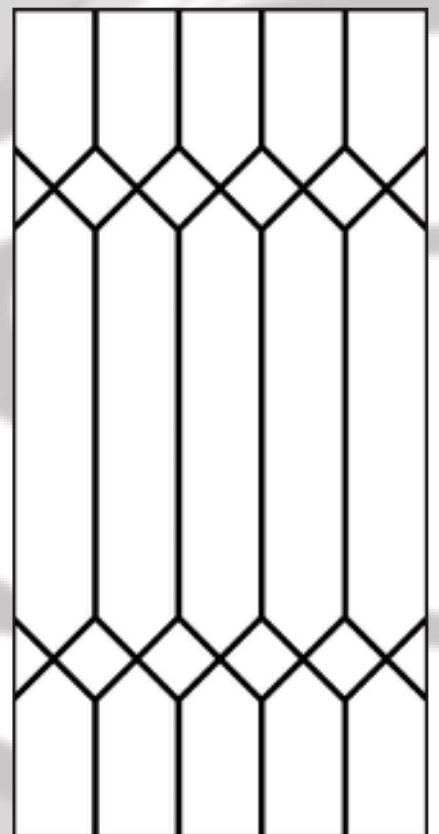

CABLD 06

Diseños Sencillos con Plomo

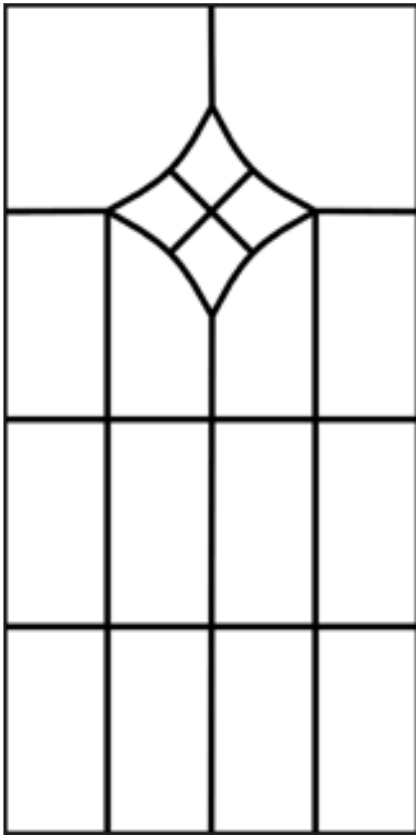

CABLD 07

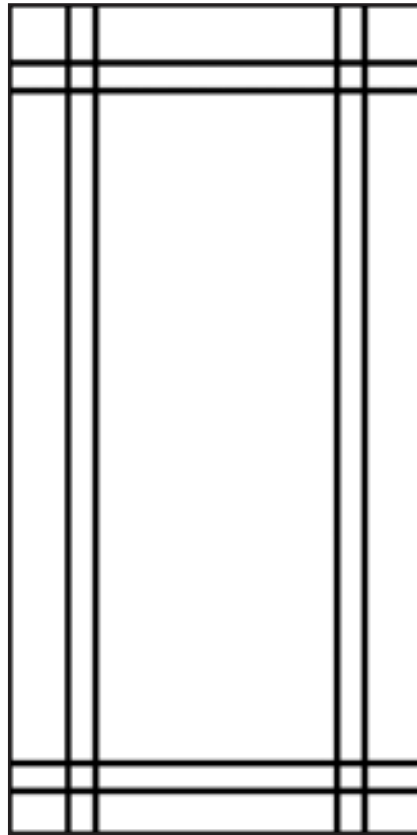

CABLD 08

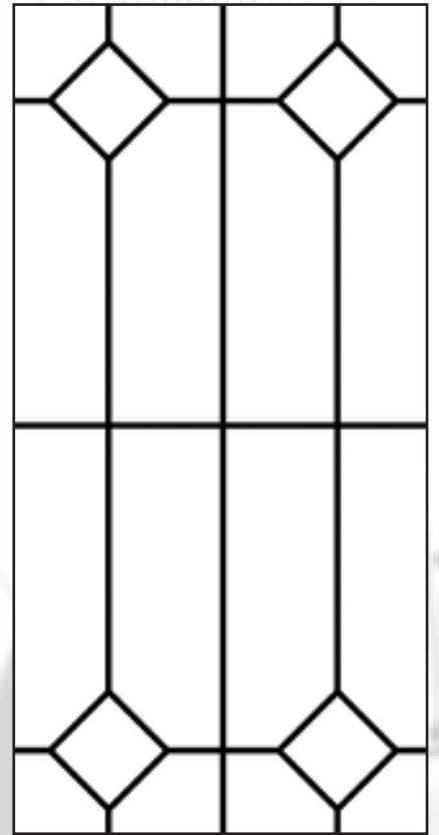

CABLD 09



CABLD 10

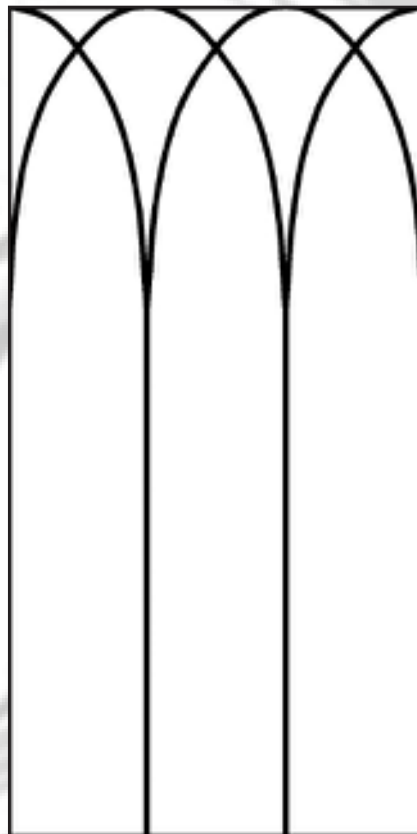

CABLD 11

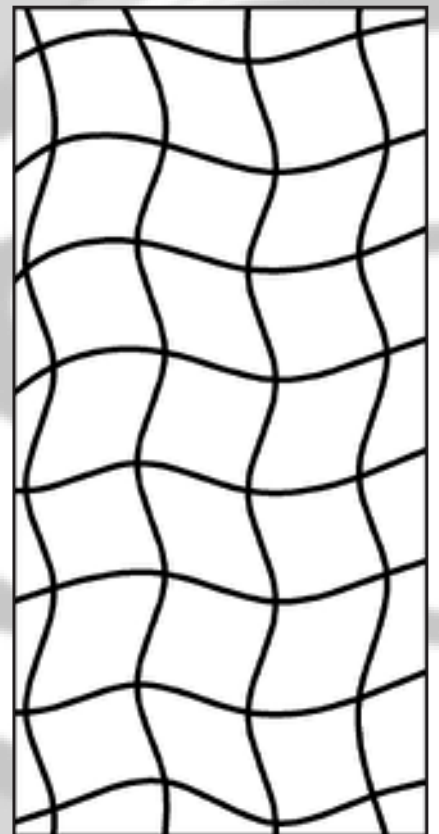

CABLD 12

Diseños Sencillos con Plomo

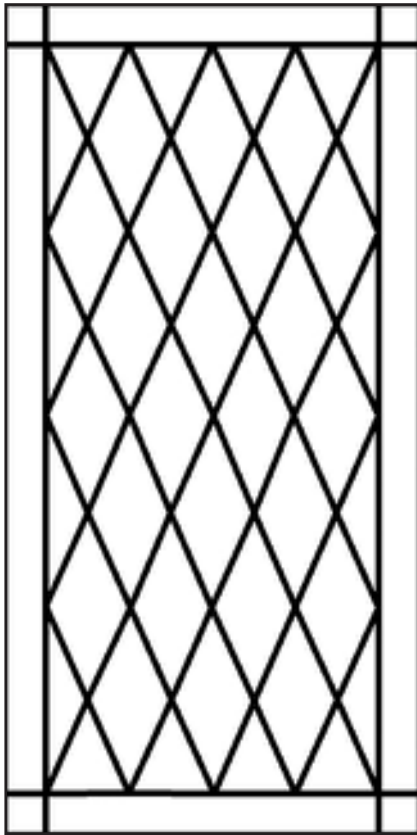

CABLD 13

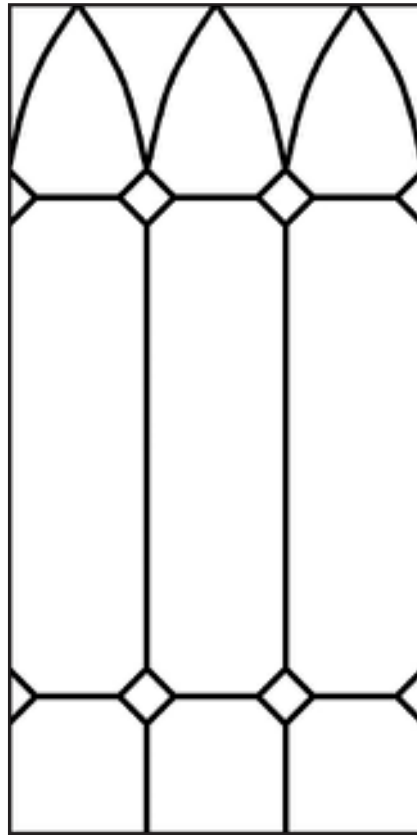

CABLD 14

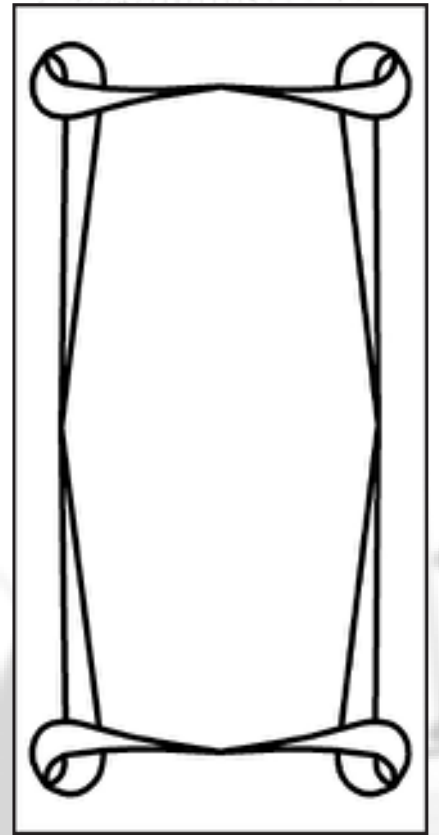

CABLD 15

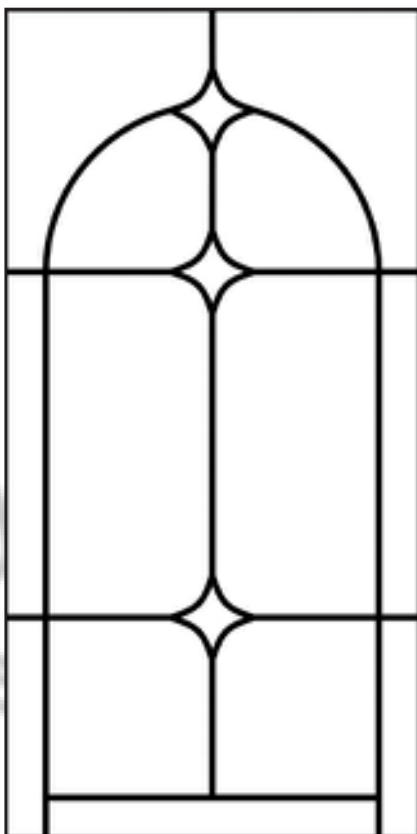

CABLD 16

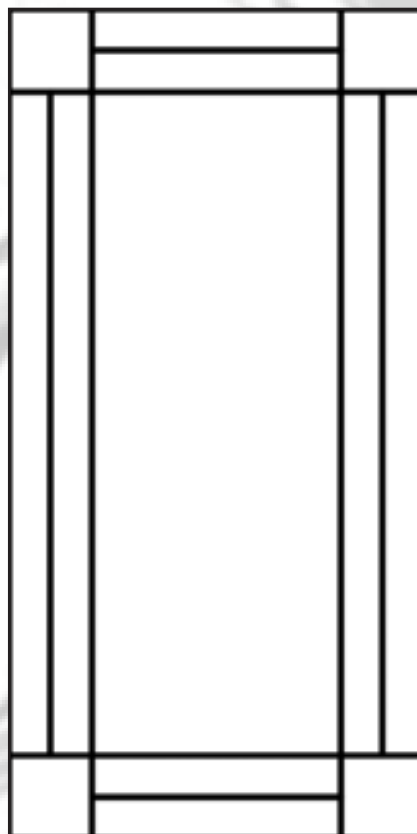

CABLD 17

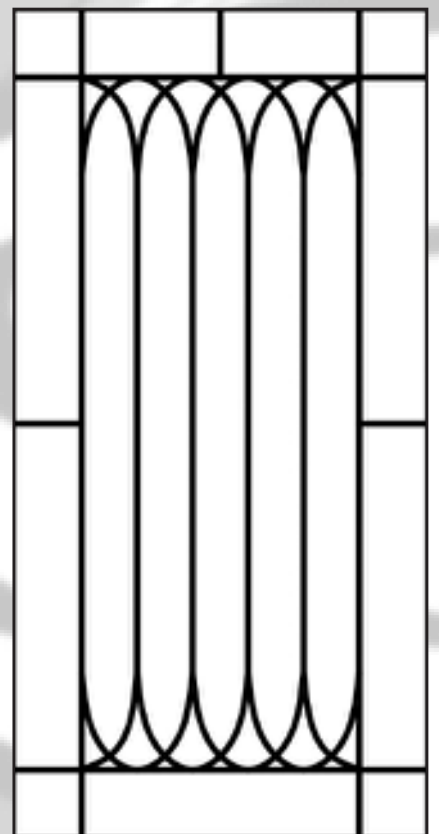

CABLD 18

Diseños Sencillos con Plomo

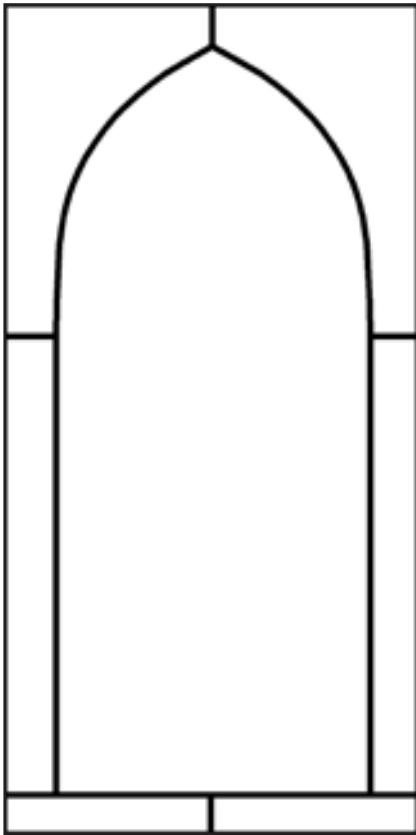

CABLD 19

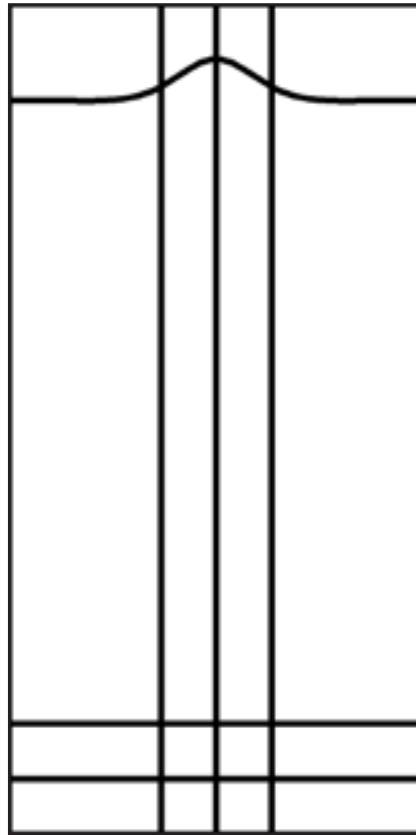

CABLD 20

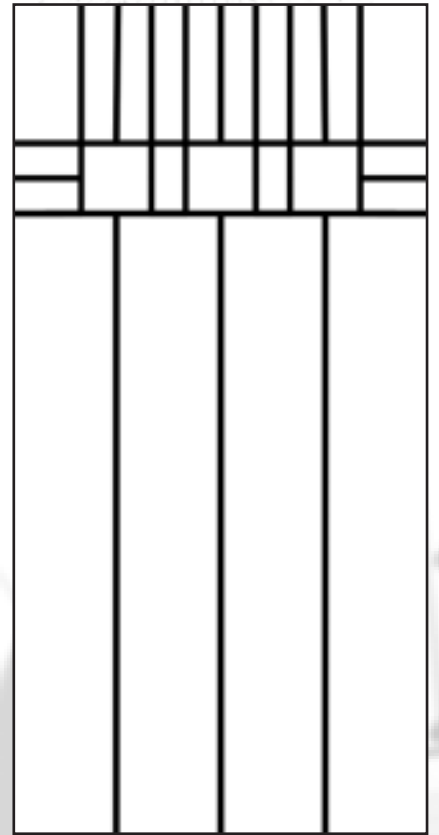

CABLD 21

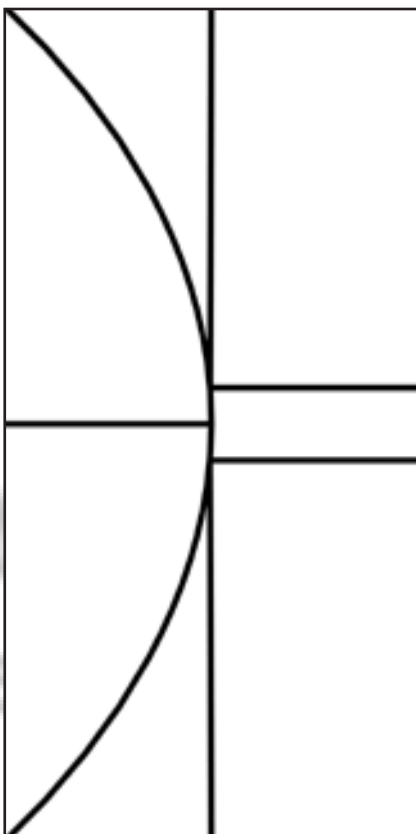

CABLD 22

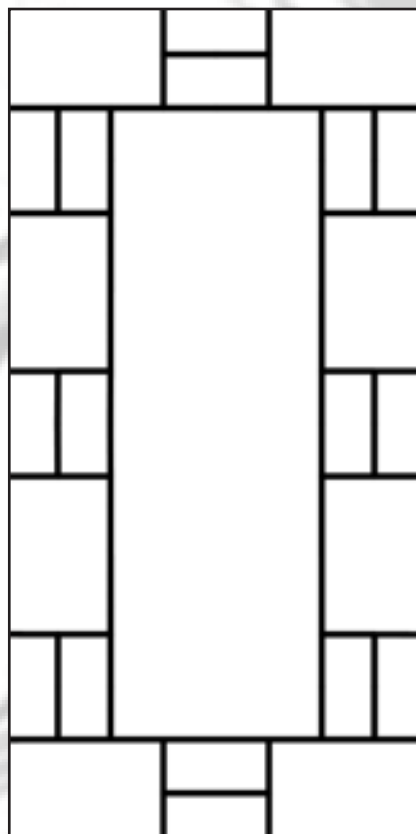

CABLD 23

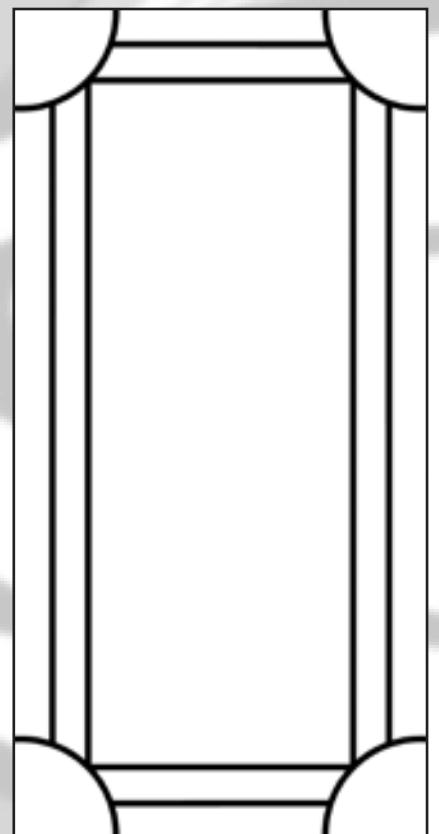

CABLD 24

Diseños Sencillos con Plomo

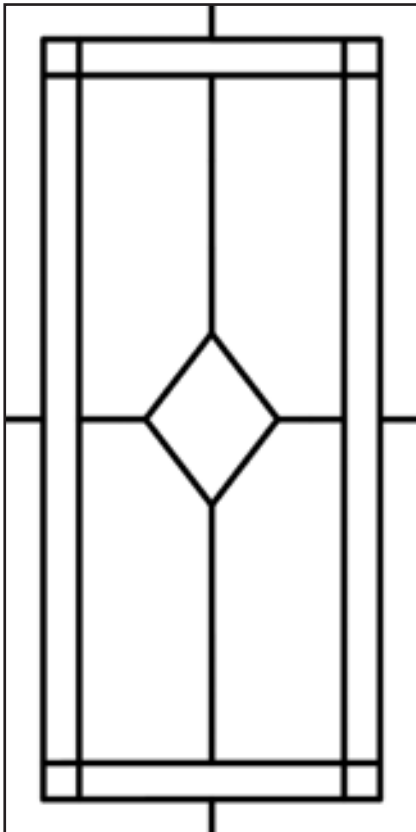

CABLD 25

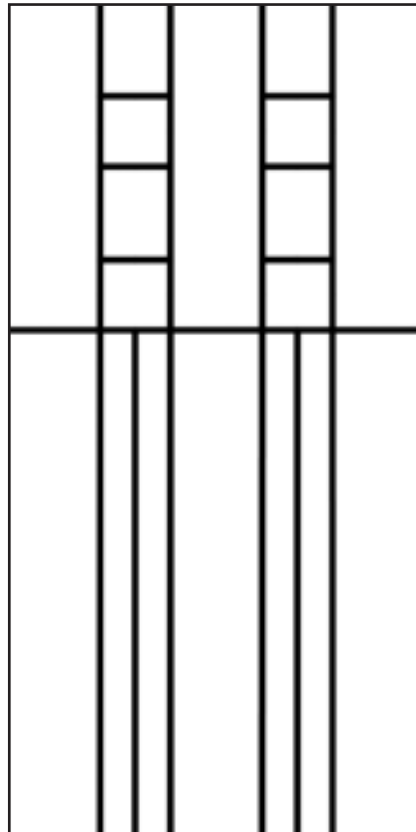

CABLD 26

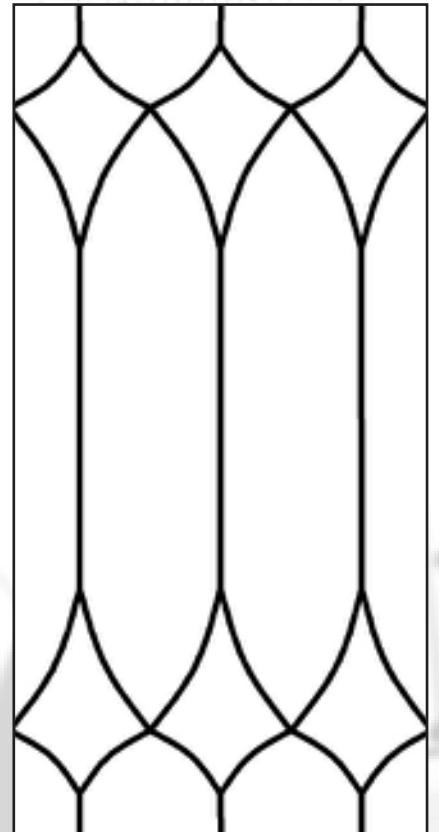

CABLD 27

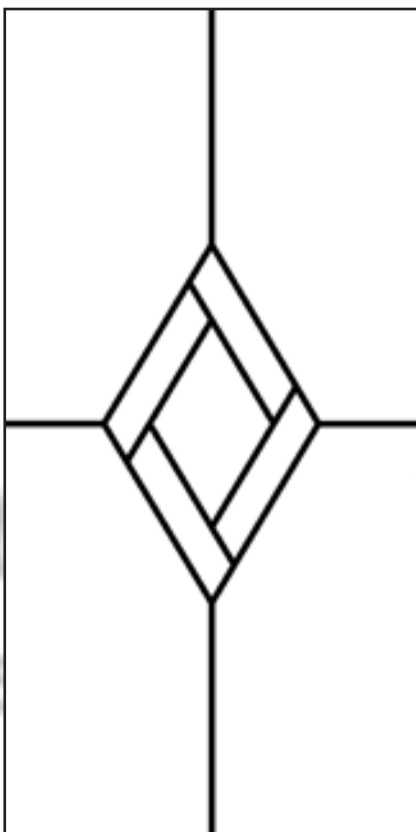

CABLD 28

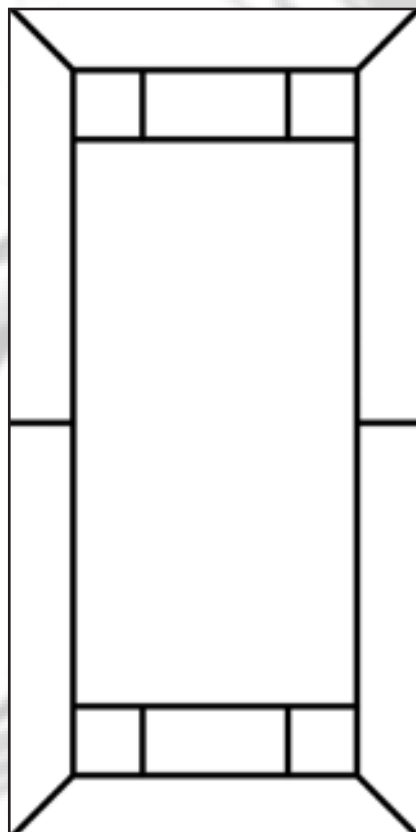

CABLD 29

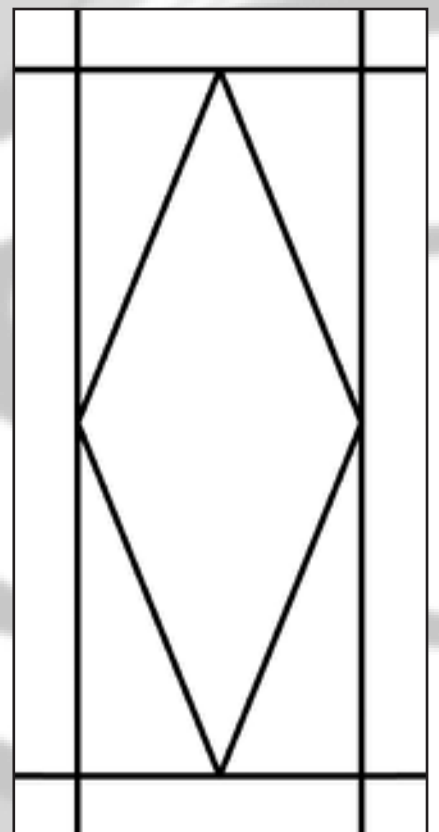

CABLD 30



Diseños de Color

El uso del color en los diseños añade vivacidad al vidrio de su gabinete de cocina o su mueble y le permite crear una pieza de vidrio decorativo verdaderamente artística. Tenemos una biblioteca extensa de colores y efectos de vidrio disponibles a nosotros que van de la transparencia sencilla a vetas tradicionales y colores de catedral que se parecen al vidrio teñido tradicional.

La gama de 90 diseños que se muestra en las 15 páginas siguientes abarca una amplia gama de estilos de vidrio decorativo, de lo tradicional a lo moderno, junto a estilos de especialista como los diseños inspirados por la obra de Charles Rennie Mackintosh y los estilos del Suroeste de Estados Unidos / la Pradería.

CABT 27

CABCON 13

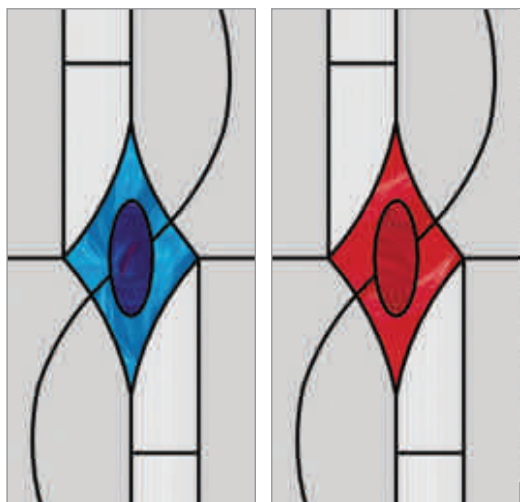
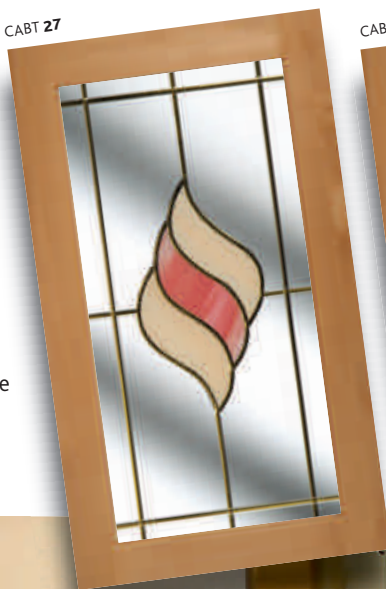

Muchos de nuestros diseños le dan la opción de escoger entre nuestra biblioteca de colores para personalizar su lastra de vidrio para combinarse con los muebles ¡o simplemente para usar su color favorito!



Piezas de Muestra

Para probar colores, ofrecemos ejemplares individuales de colores, impresos sobre hojas de acetato de 115mm x 60mm (4½" x 2¼") - lo ideal para coordinar los colores de los muebles y ver el detalle del patrón.



Estilo de Mackintosh

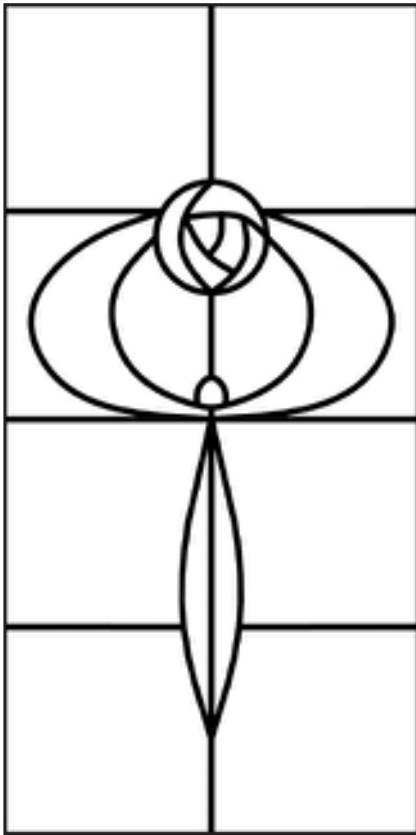

CABMK 01

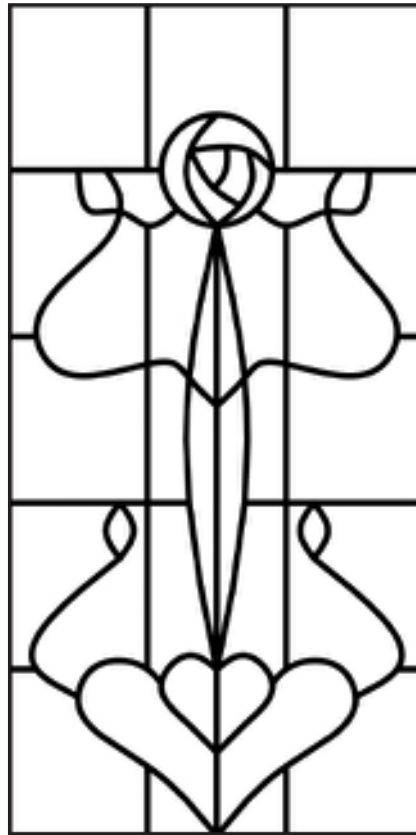

CABMK 02

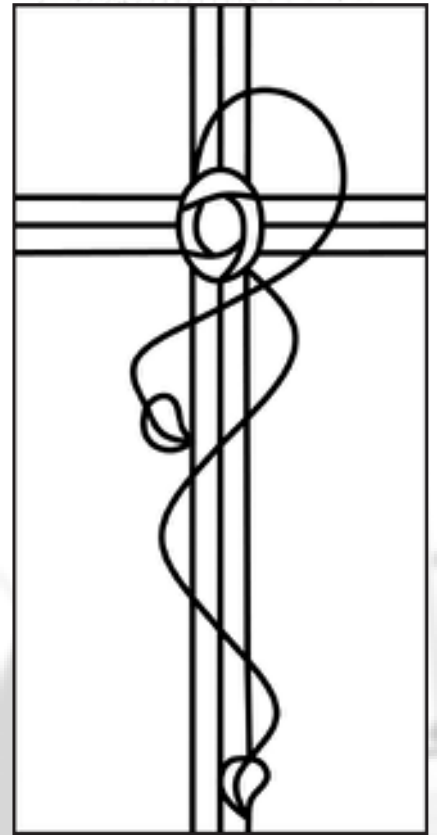

CABMK 03

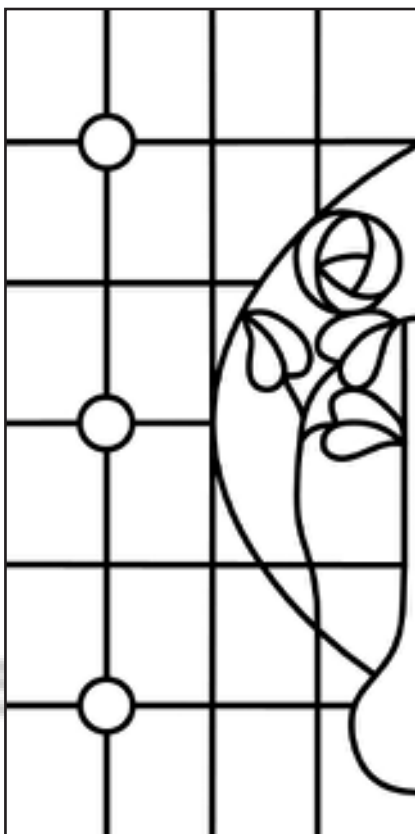

CABMK 04/05

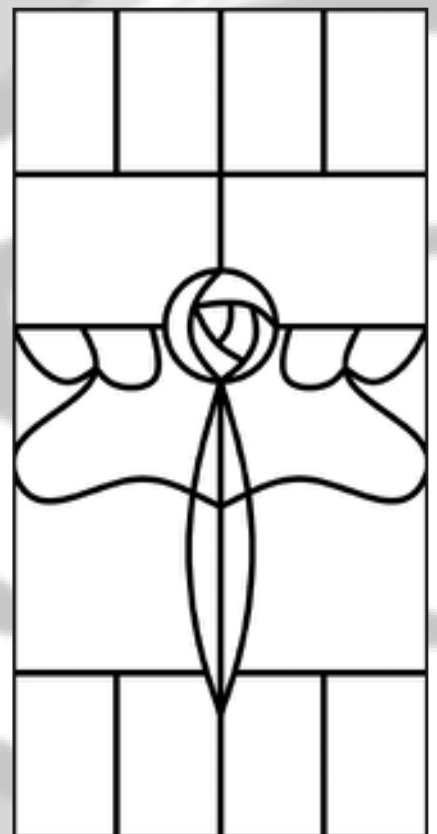
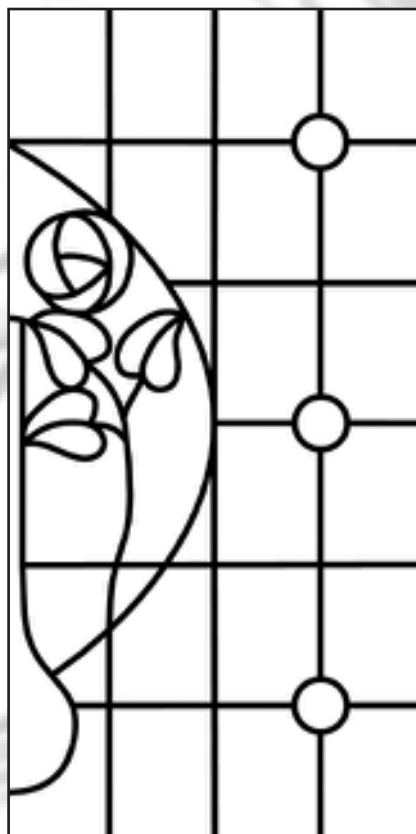

CABMK 06

Contemporáneos

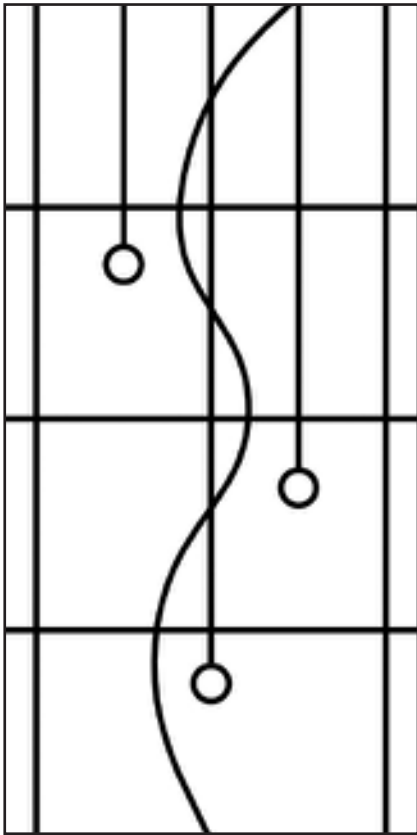

CABCON 01

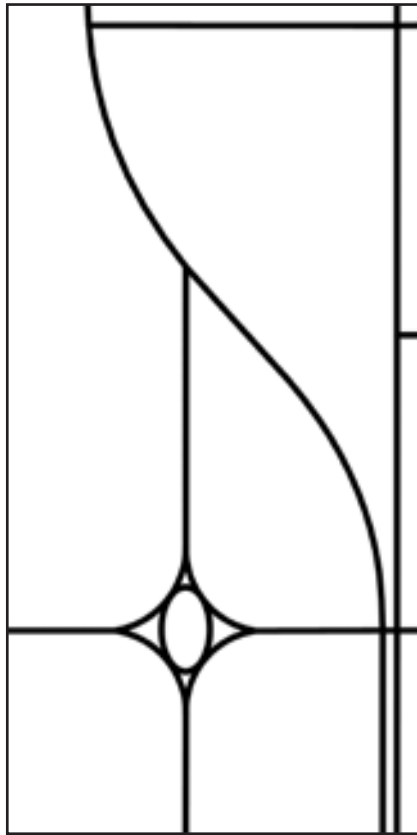

CABCON 02

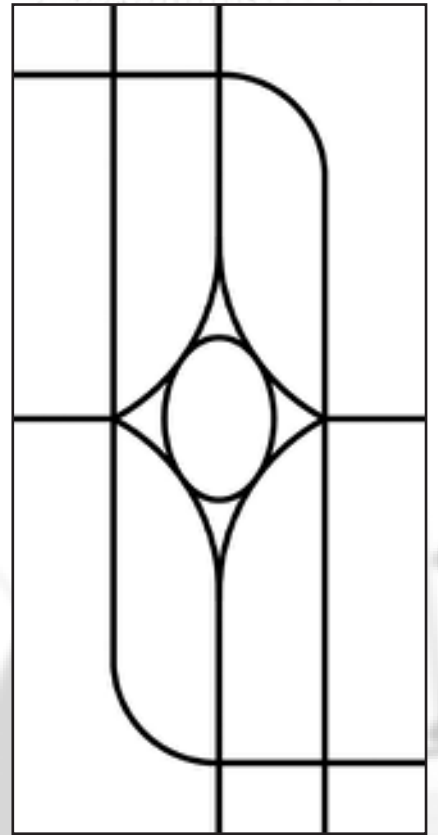

CABCON 03

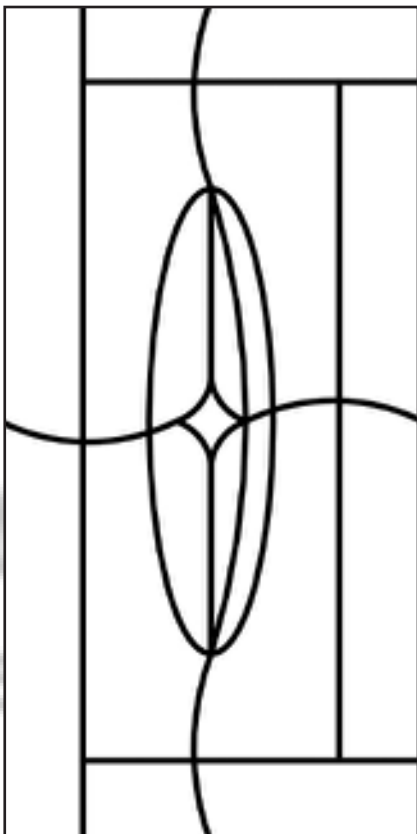

CABCON 04

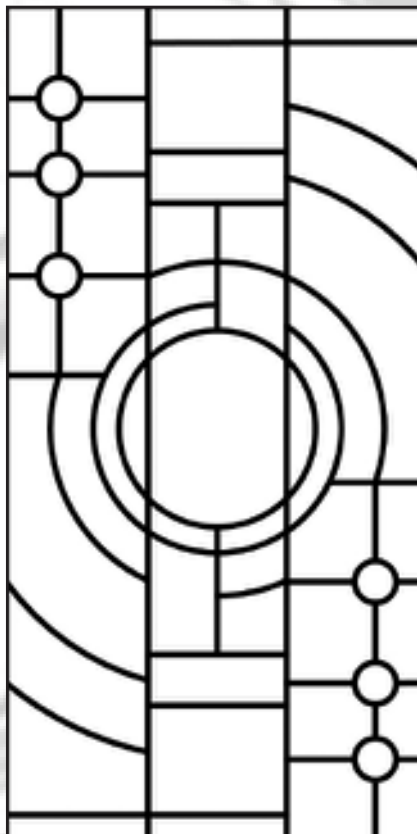

CABCON 05

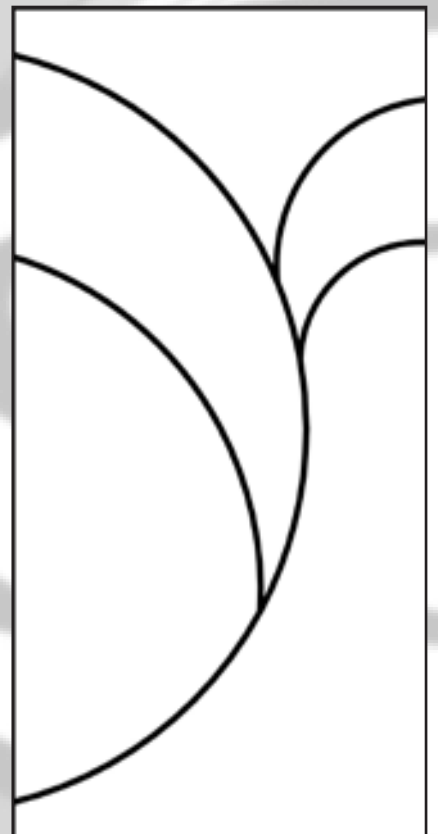

CABCON 06

Contemporáneos

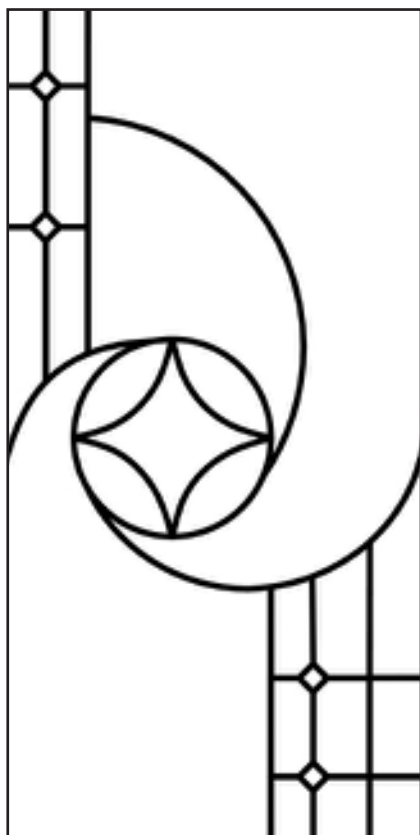

CABCON 07

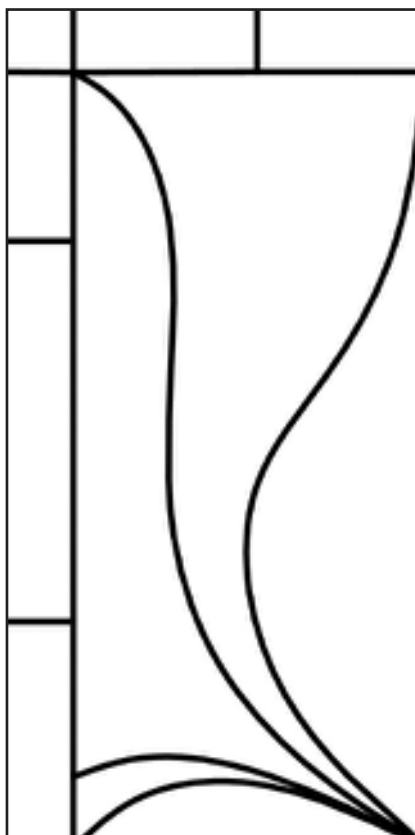

CABCON 08/09

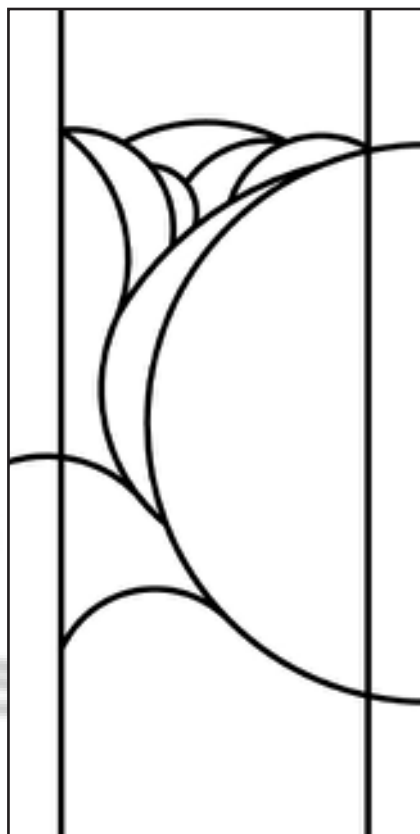
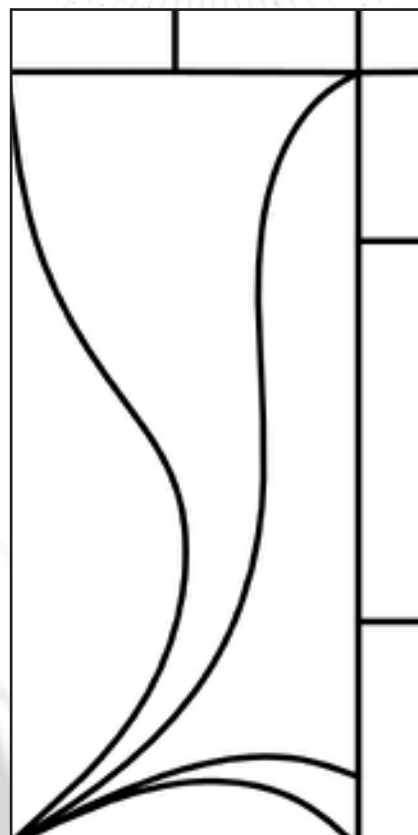

CABCON 10/11

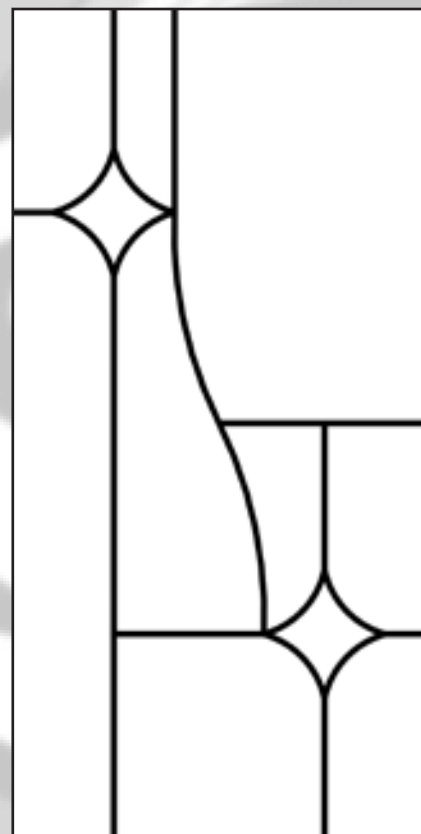
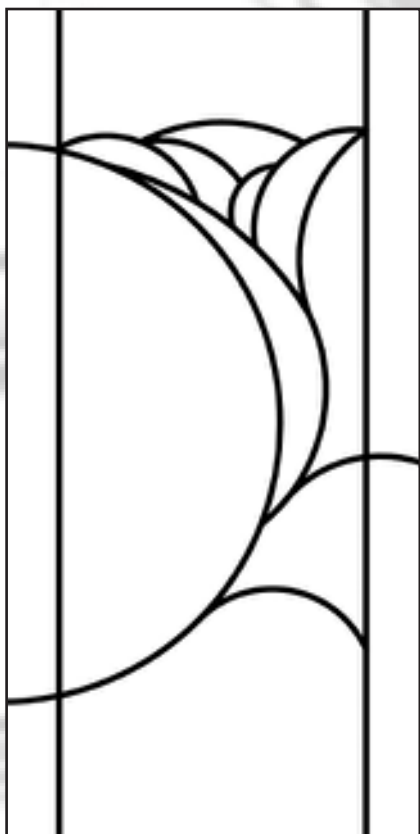

CABCON 12

Contemporáneos

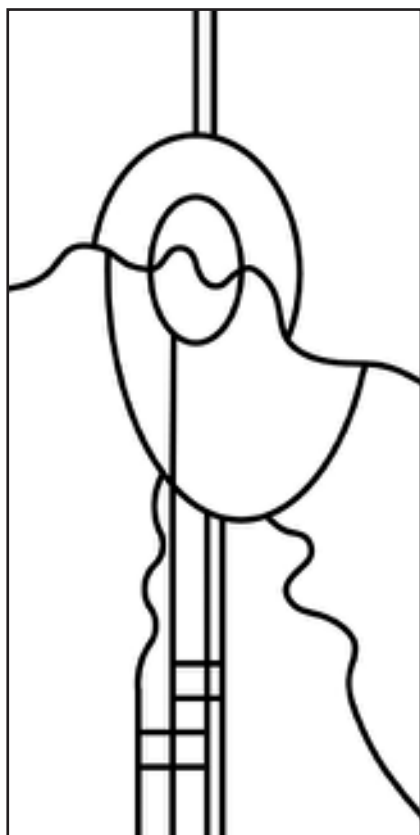

CABCON 13

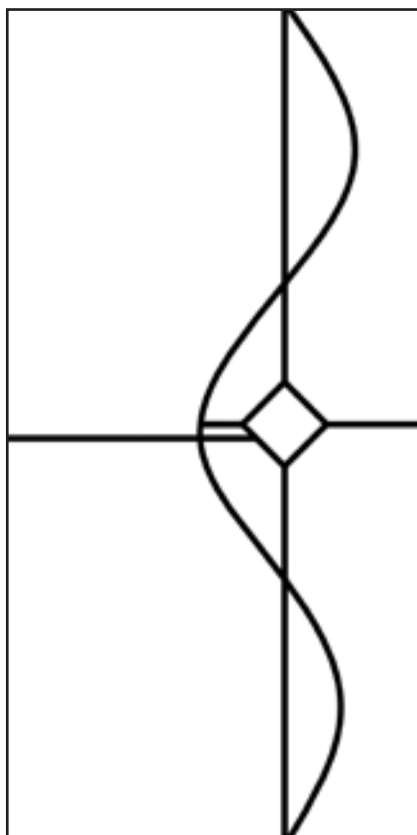

CABCON 14

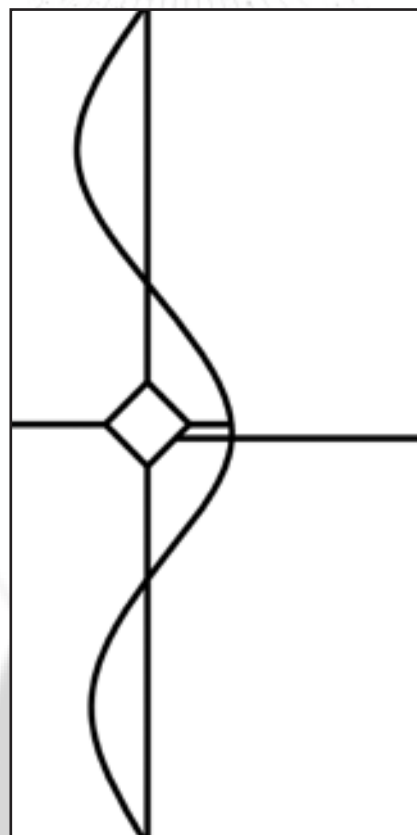

CABCON 15

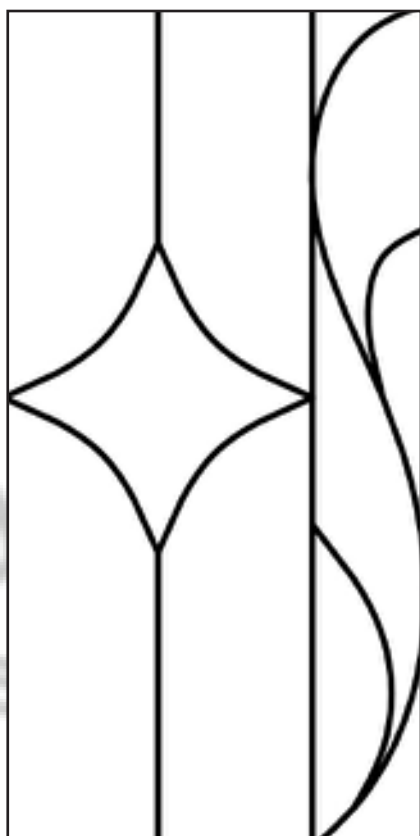

CABCON 16

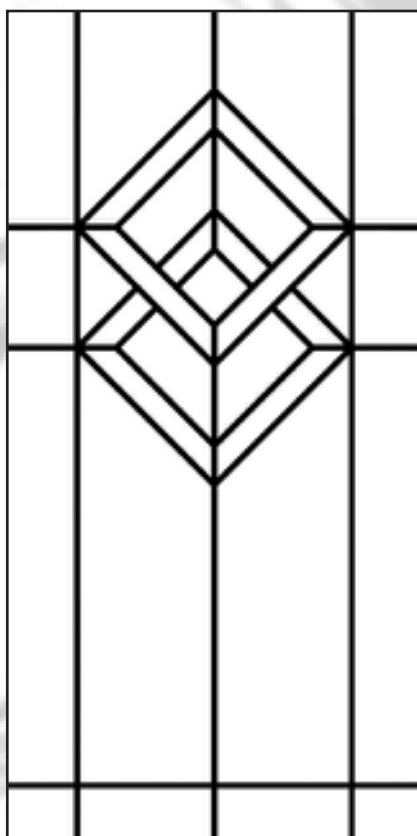

CABCON 17

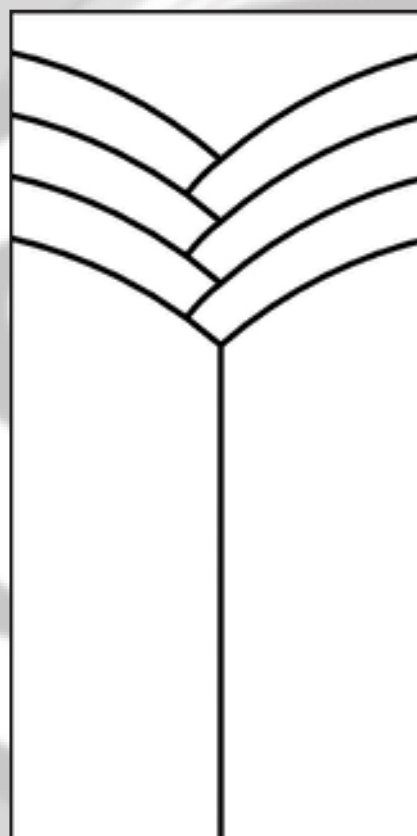

CABCON 18

Contemporáneos

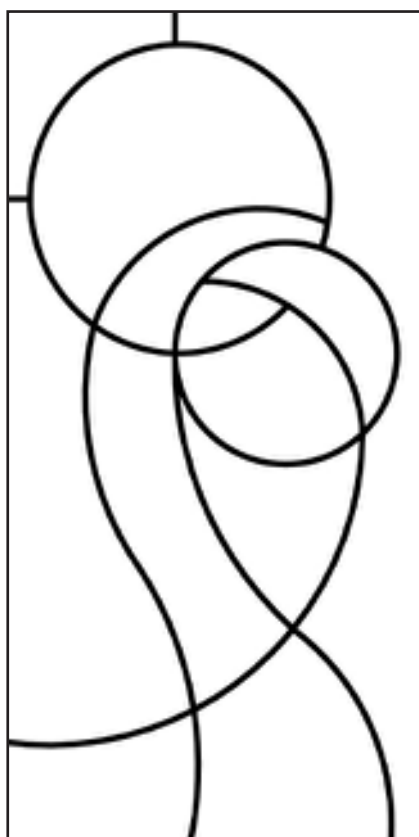

CABCON 19

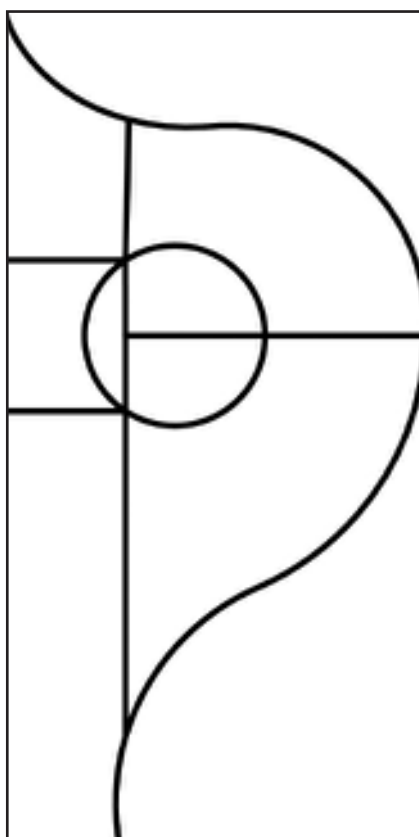

CABCON 20

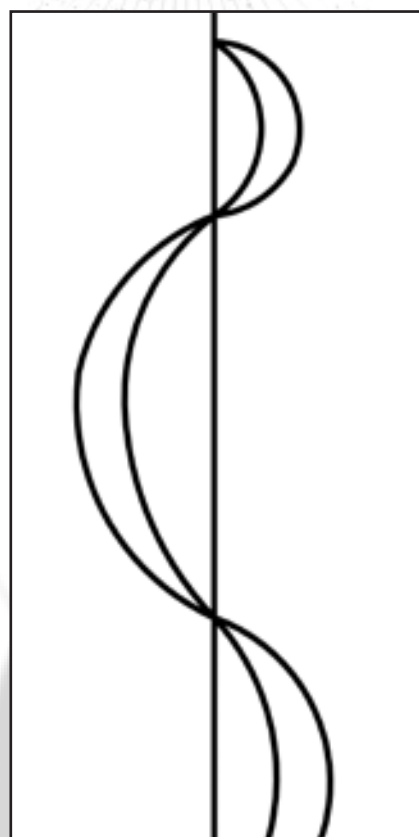

CABCON 21

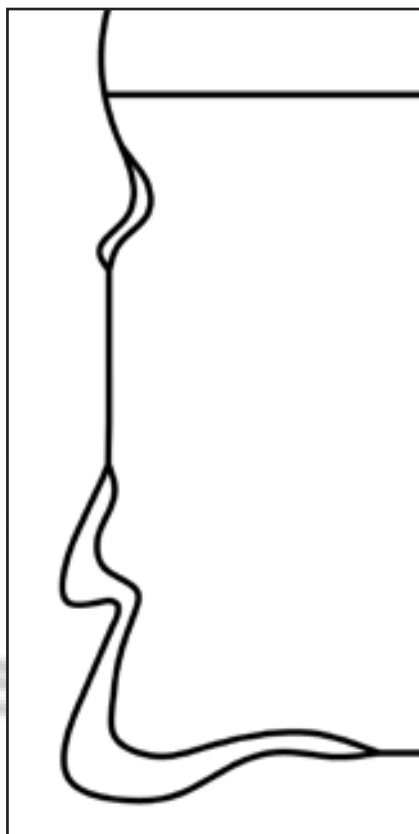

CABCON 22/23

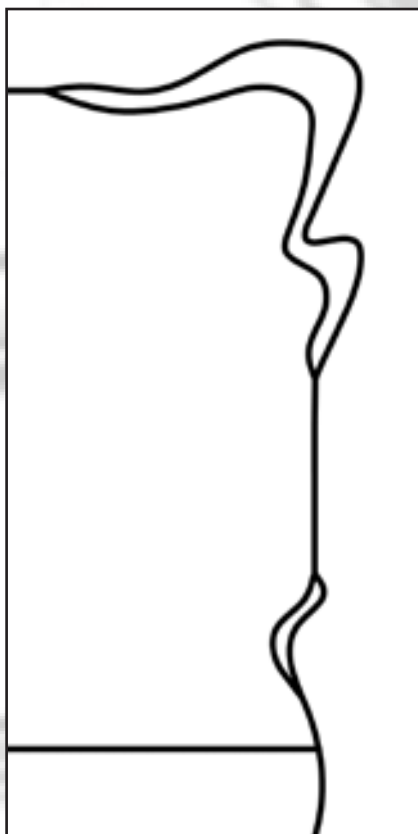

CABCON 24

Contemporáneos

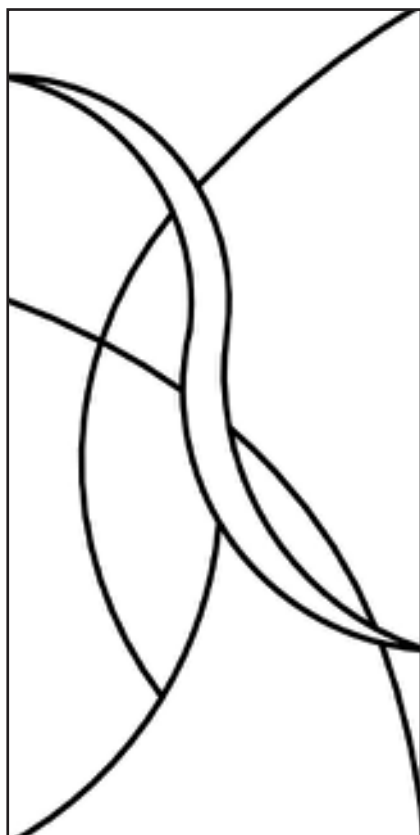

CABCON 25

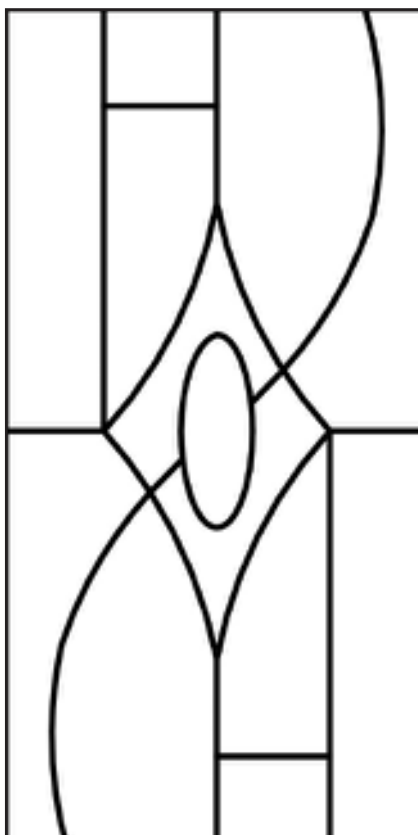

CABCON 26

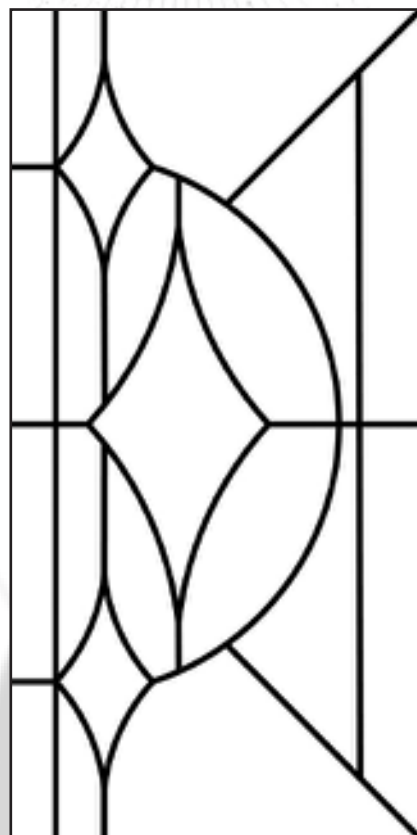

CABCON 27

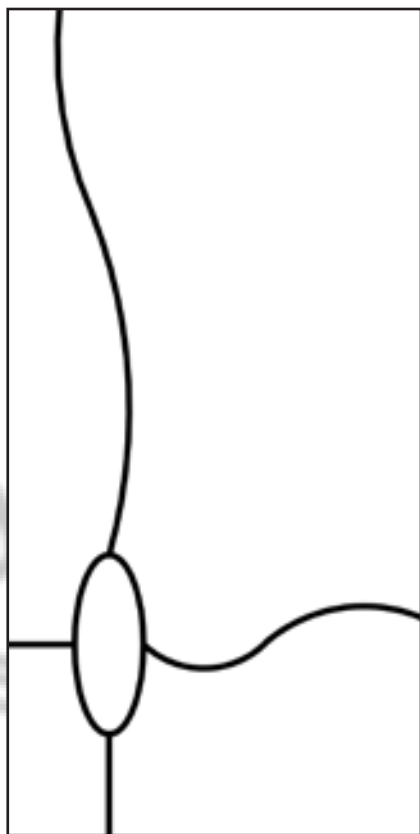

CABCON 28

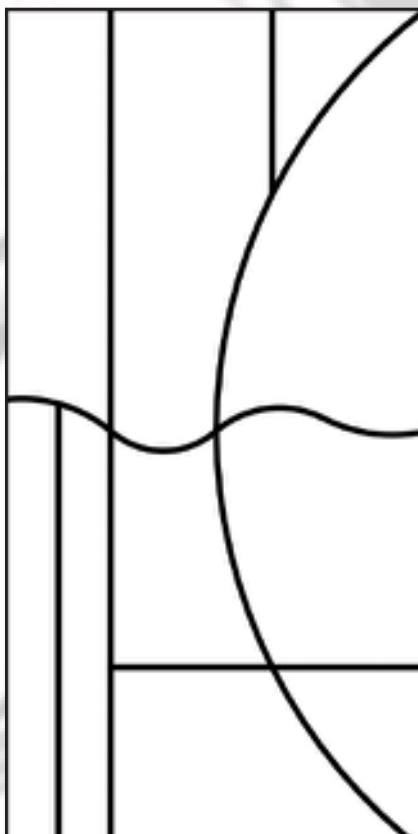

CABCON 29

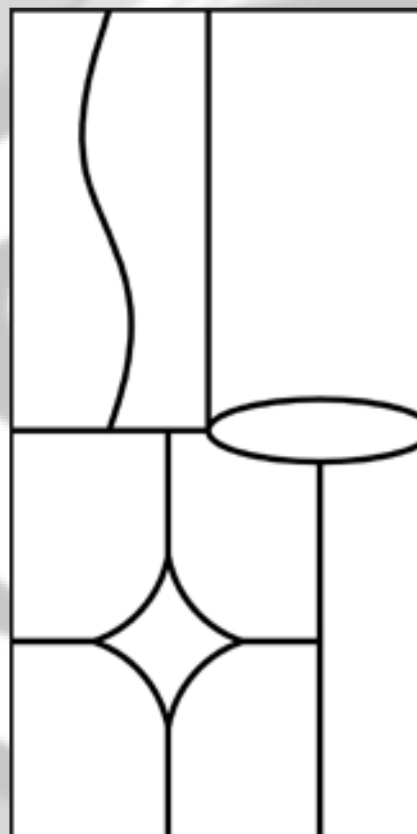

CABCON 30

Inspirados por el Suroeste / la Pradería

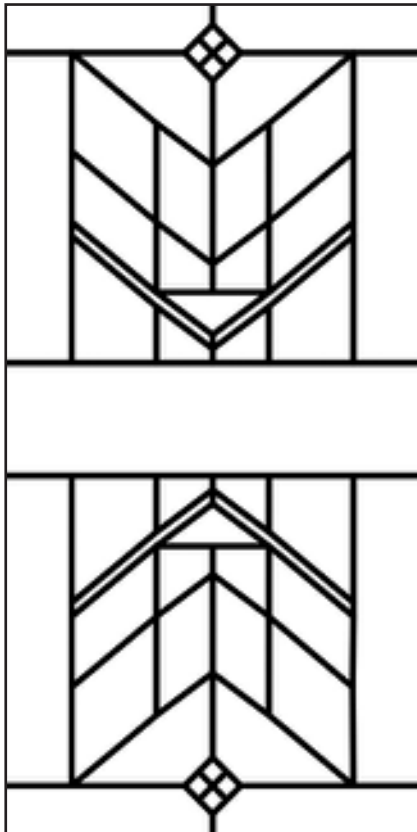

CABSW 01

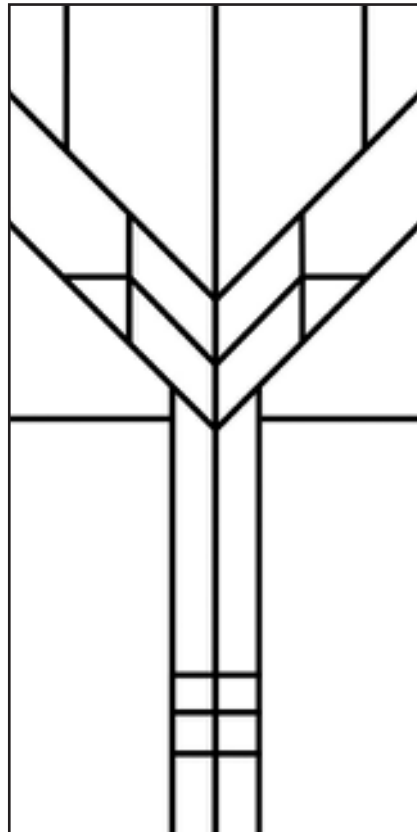

CABSW 02

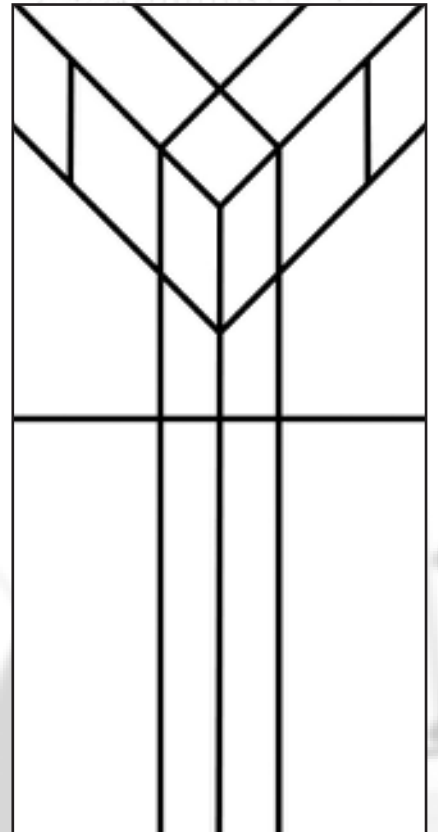

CABSW 03

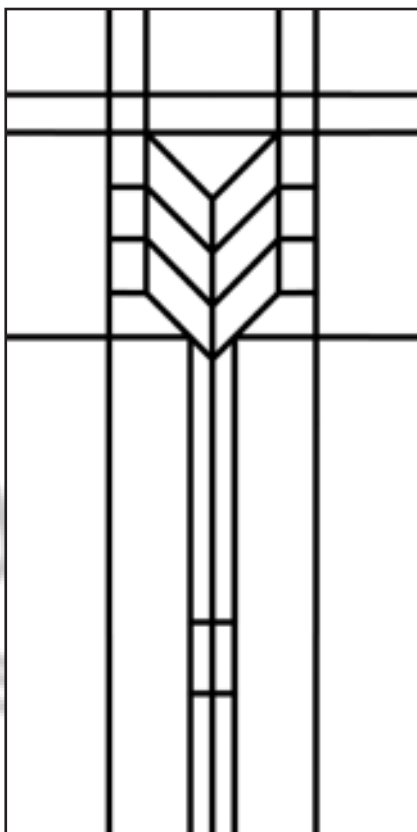

CABSW 04

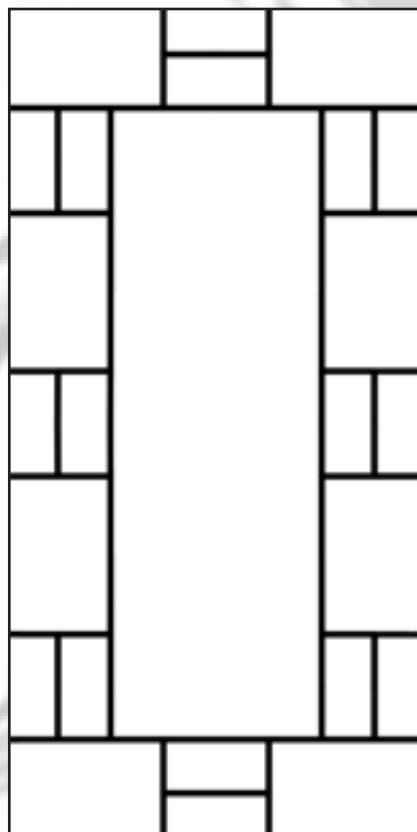

CABSW 05

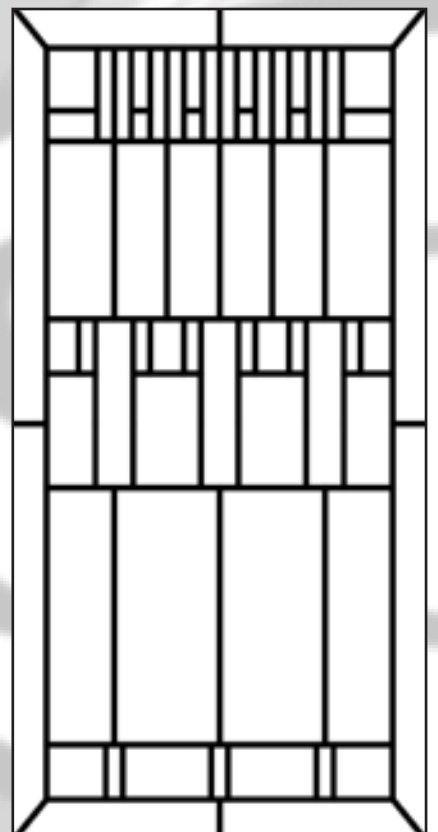

CABSW 06

Flores

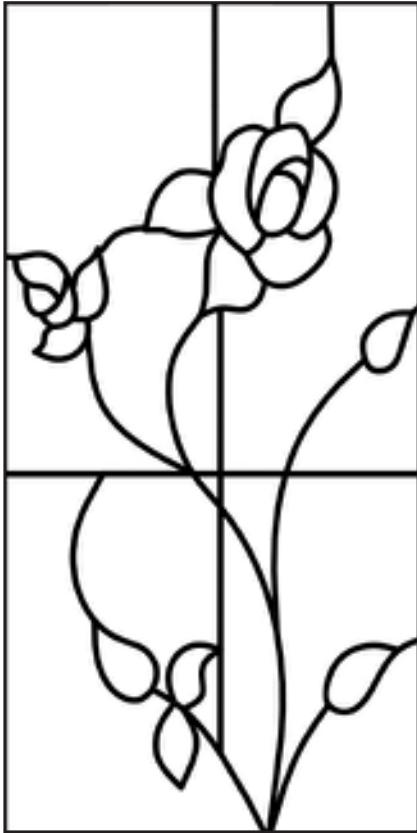

CABFL 01

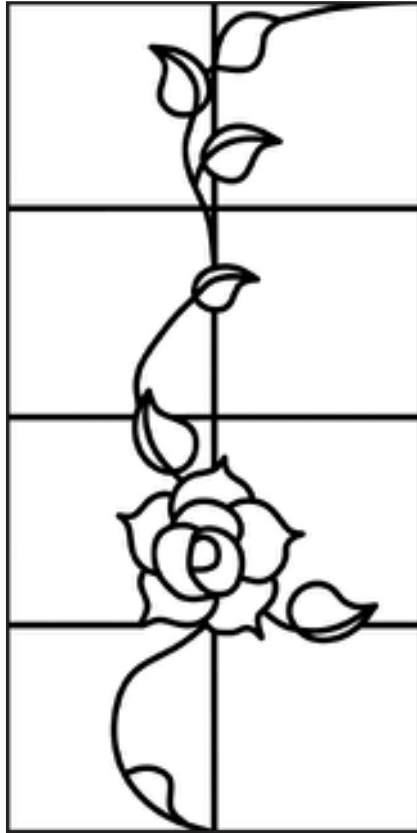

CABFL 02

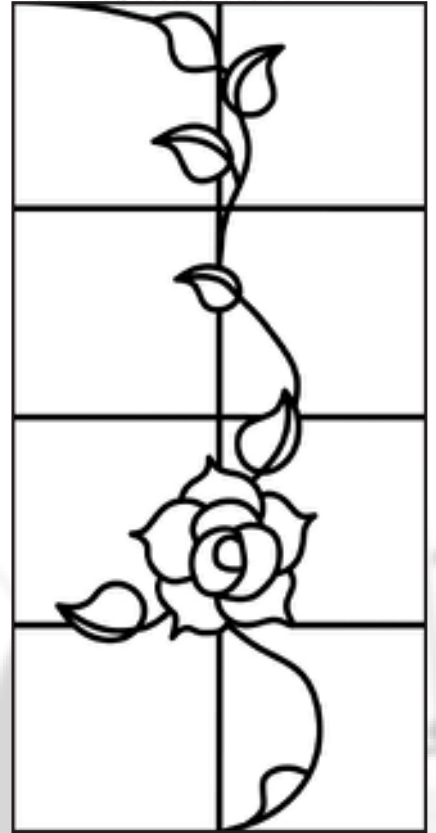

CABFL 03

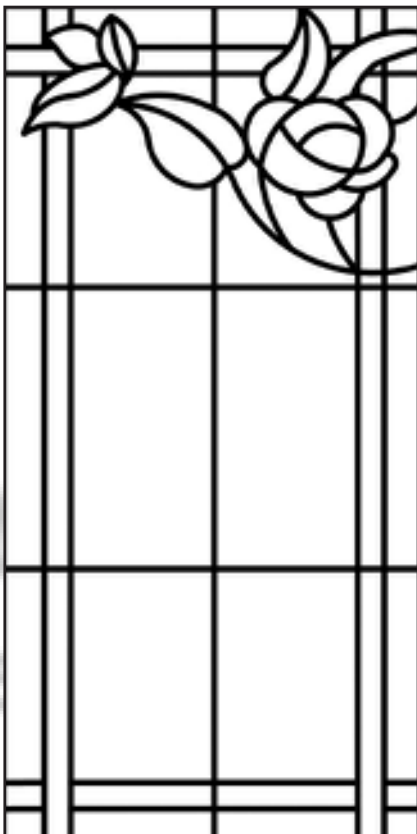

CABFL 04

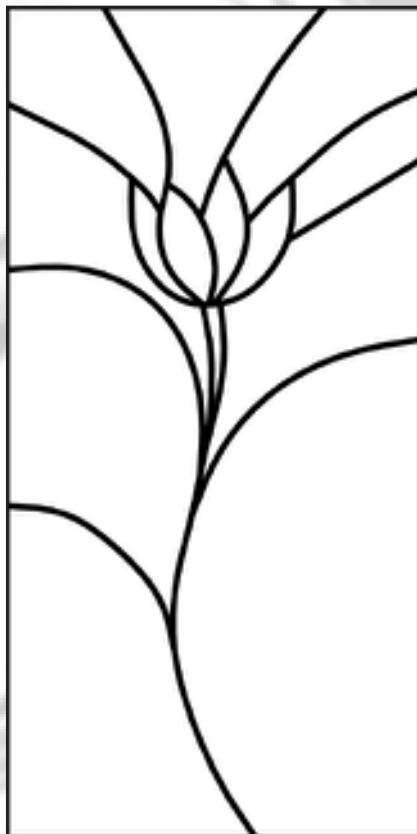

CABFL 05

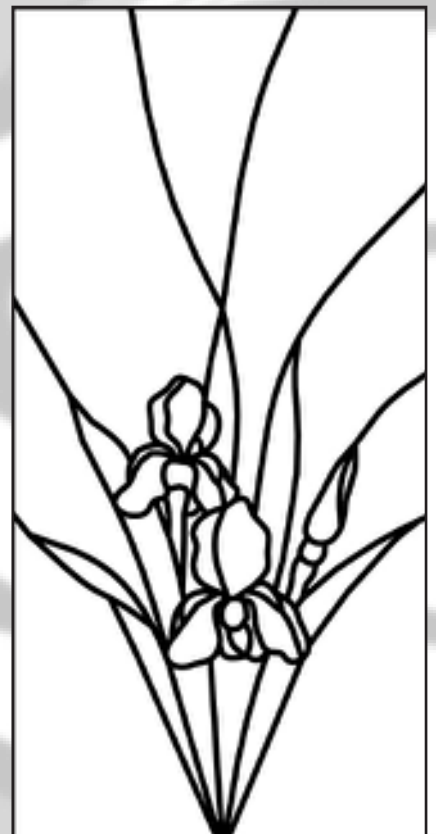

CABFL 06

Flores

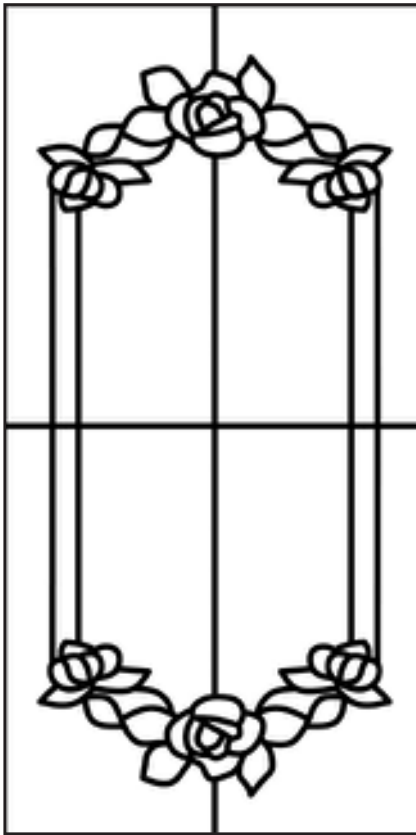

CABFL 07

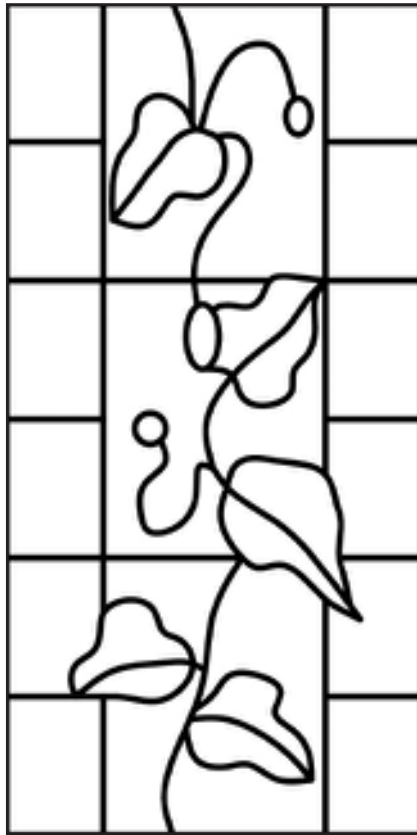

CABFL 08



CABFL 09



CABFL 10

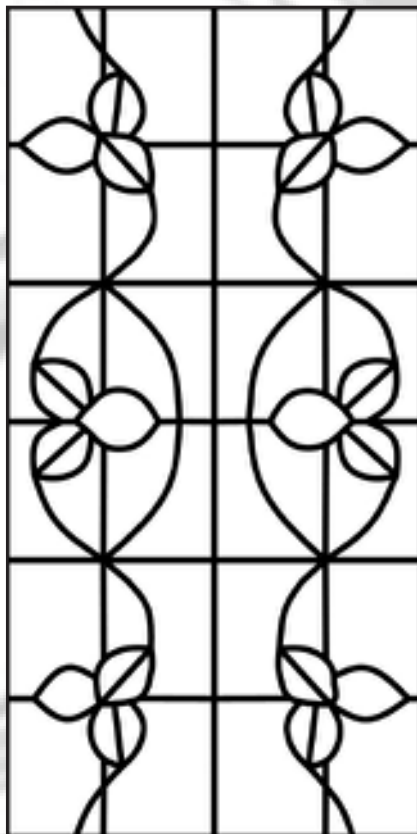

CABFL 11



CABFL 12

Tradicionales

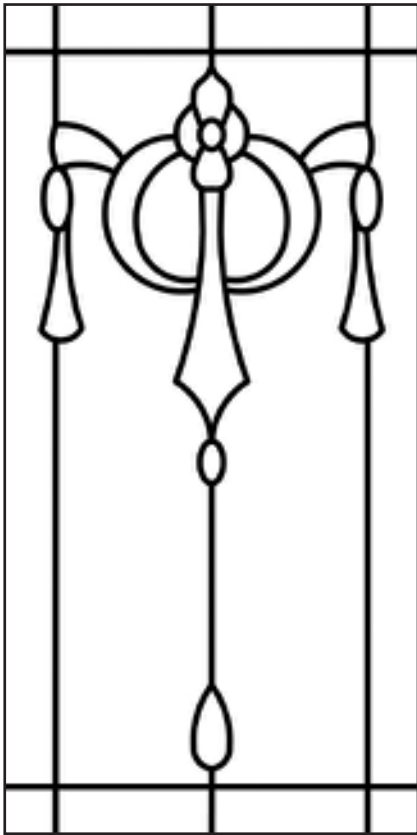

CABT 01

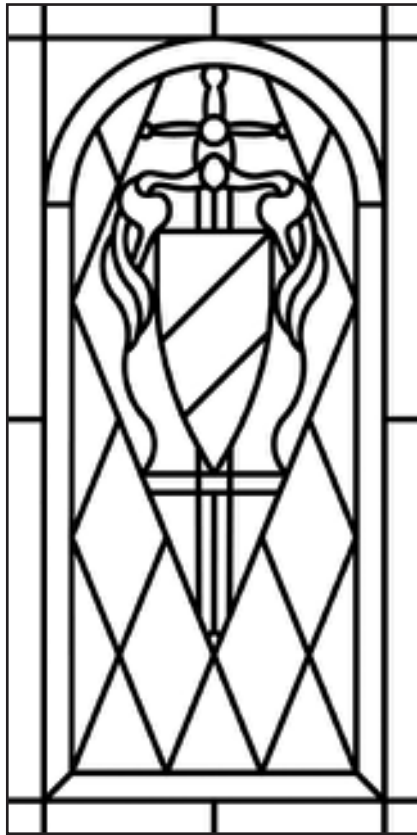

CABT 02

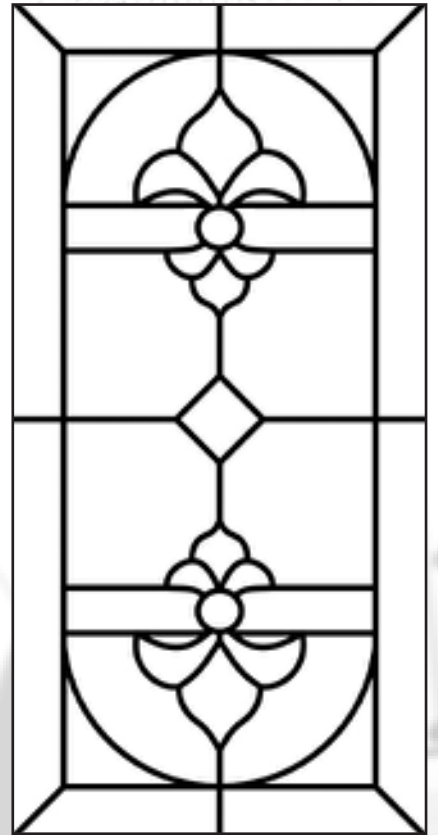

CABT 03

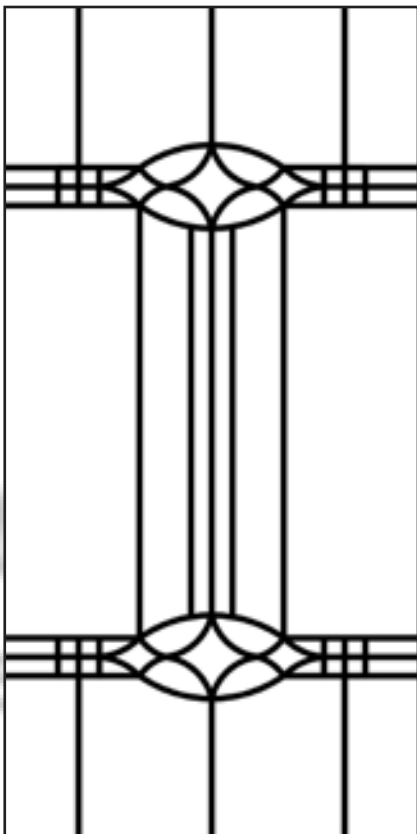

CABT 04

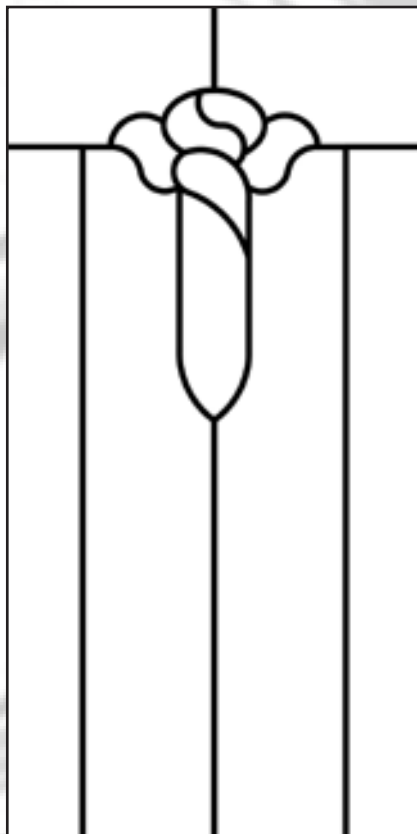

CABT 05

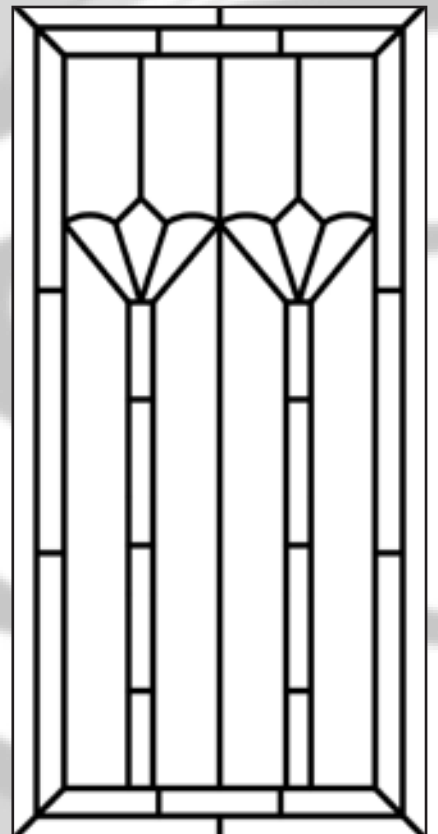

CABT 06

Tradicionales

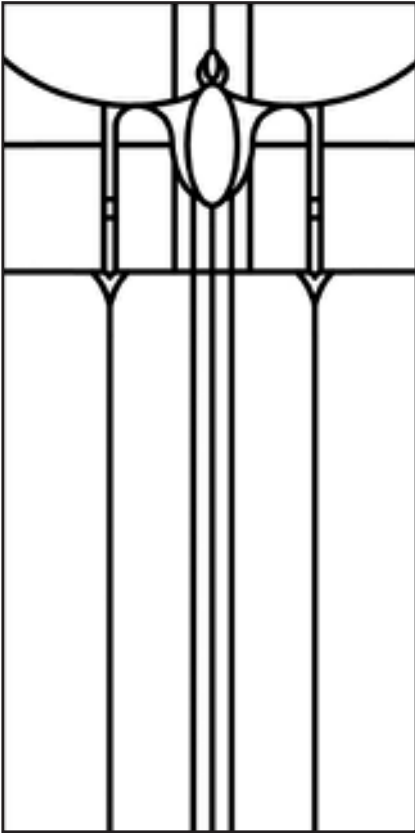

CABT 07

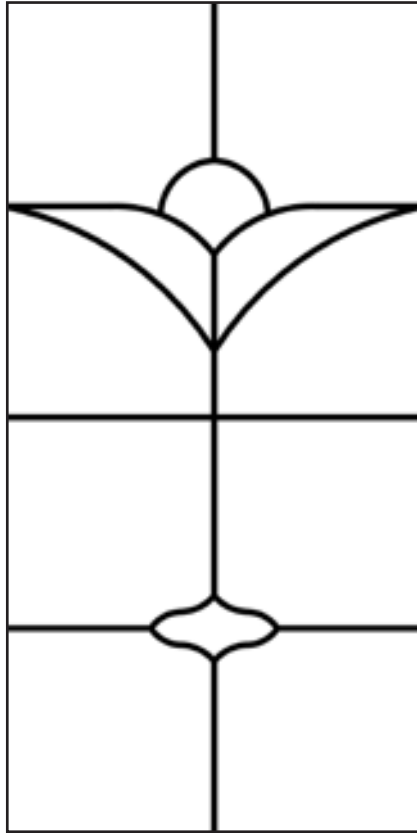

CABT 08

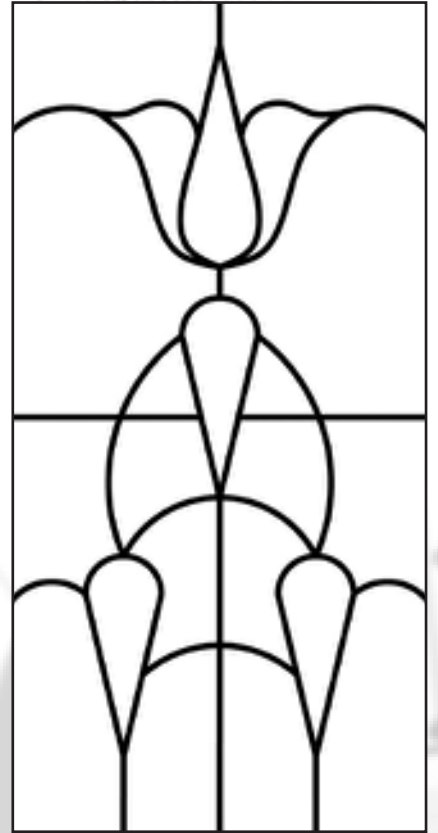

CABT 09

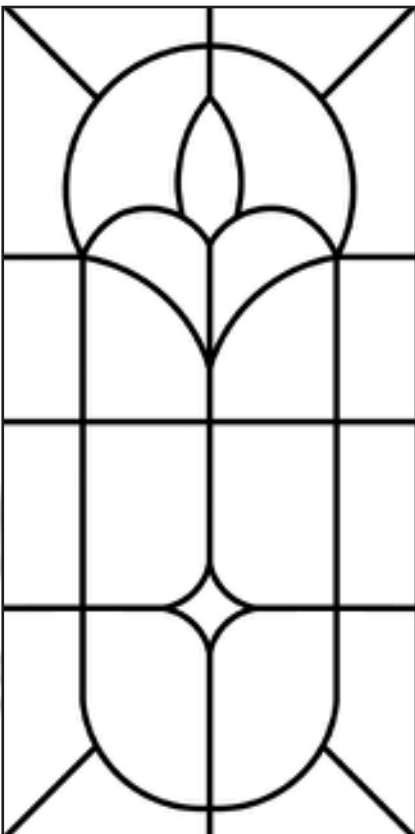

CABT 10

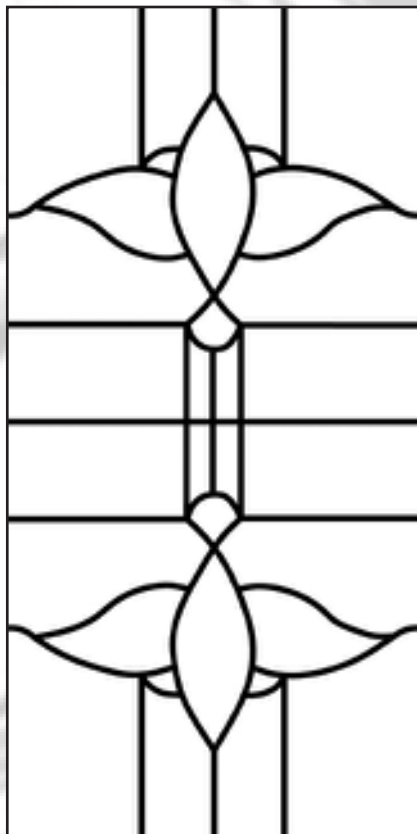

CABT 11

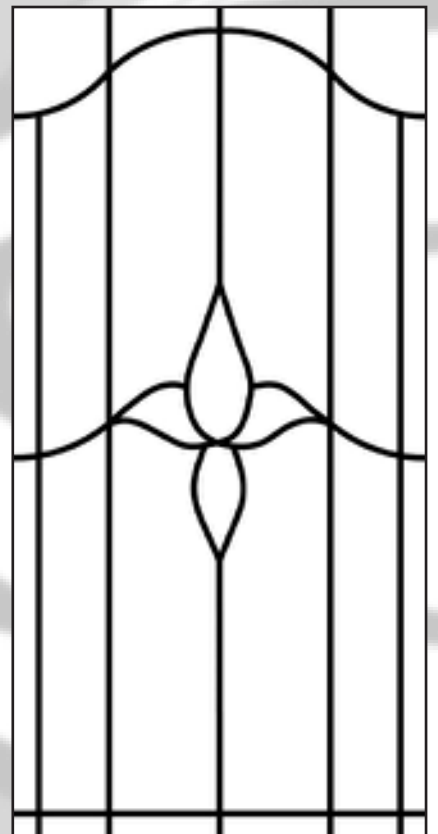

CABT 12

Tradicionales

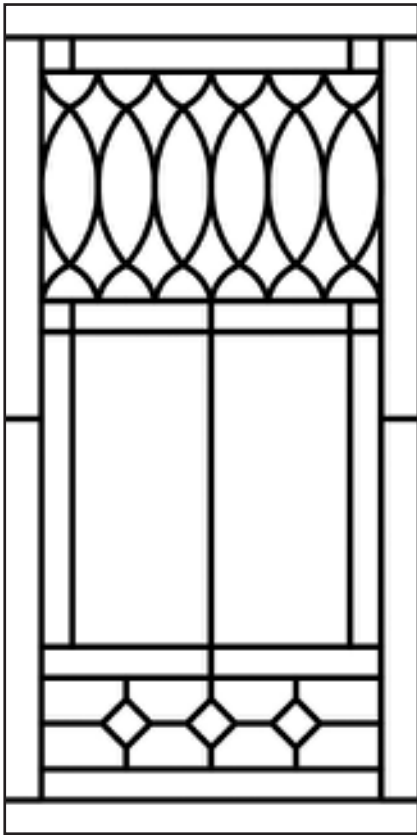

CABT 13

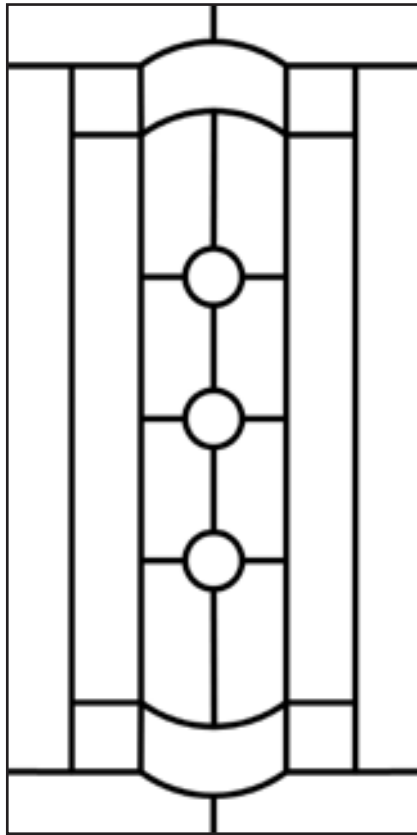

CABT 14

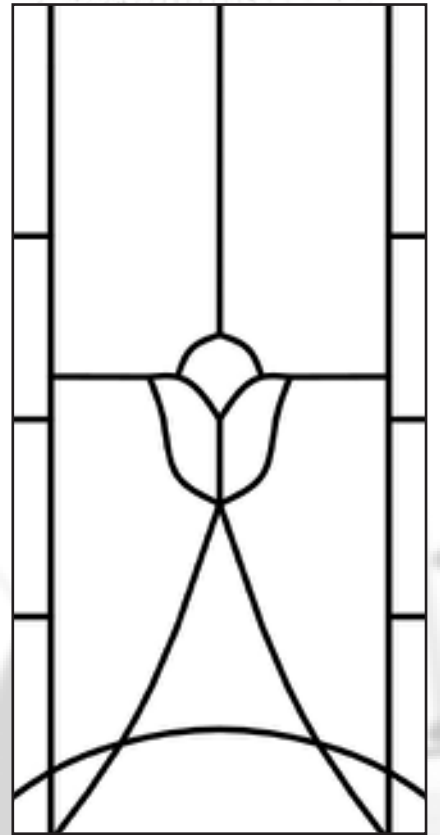

CABT 15

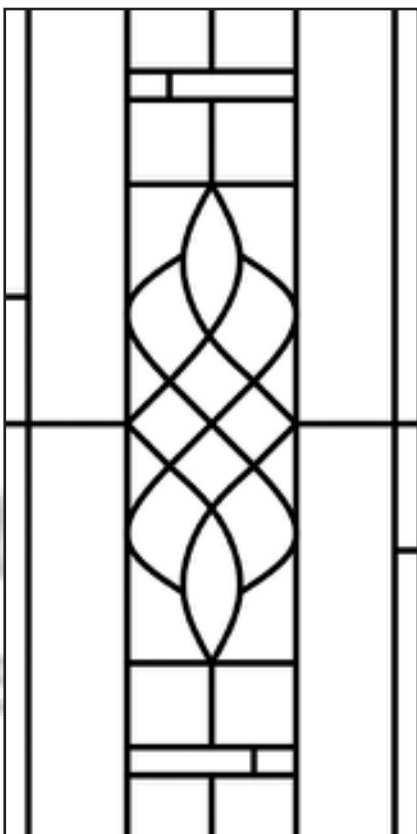

CABT 16

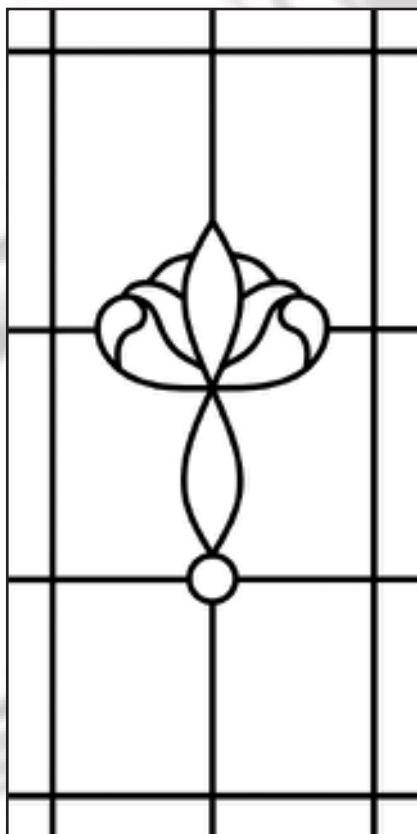

CABT 17

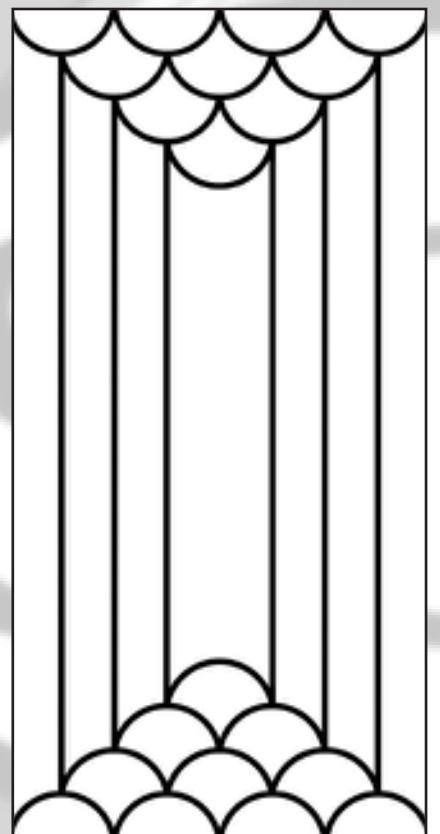

CABT 18

Tradicionales

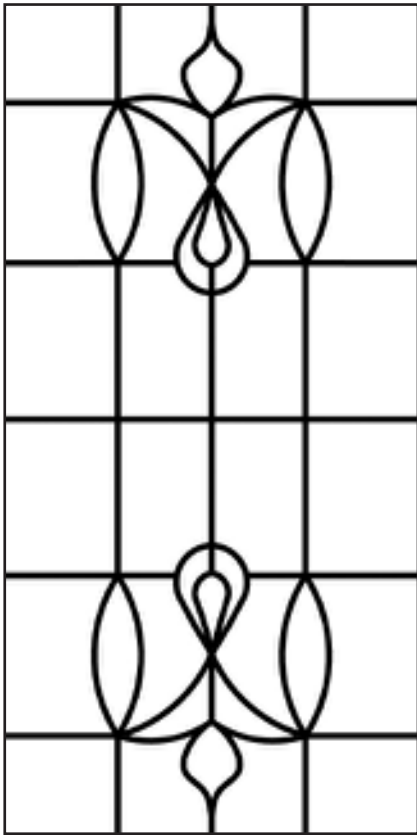

CABT 19

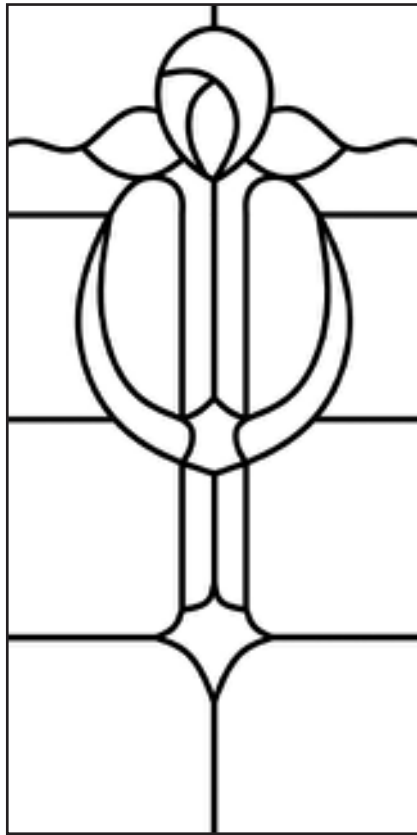

CABT 20

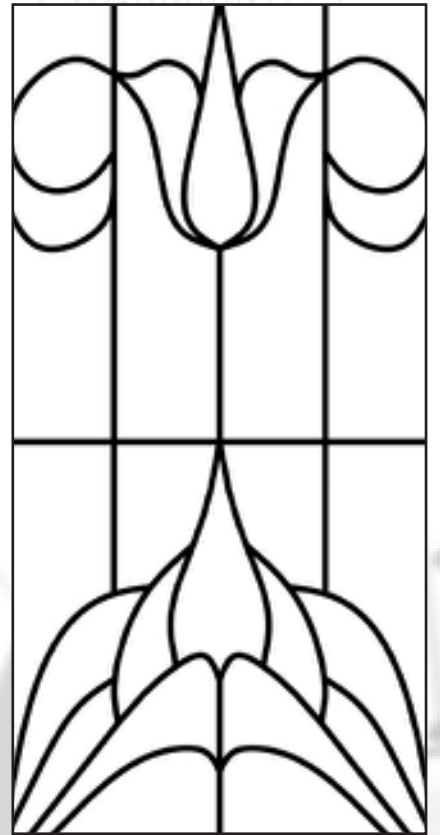

CABT 21

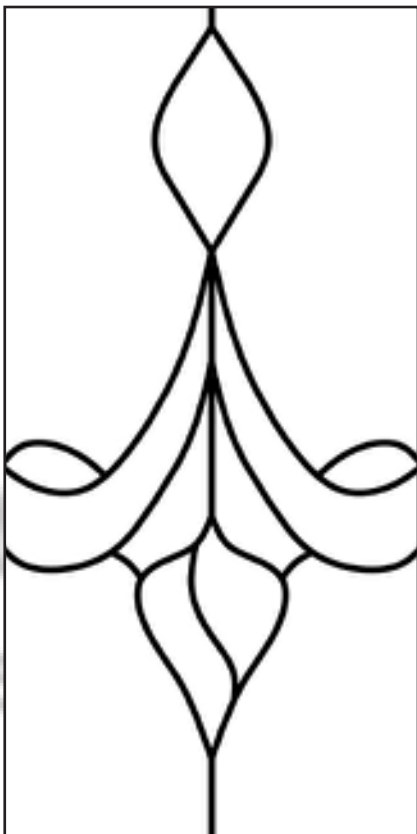

CABT 22

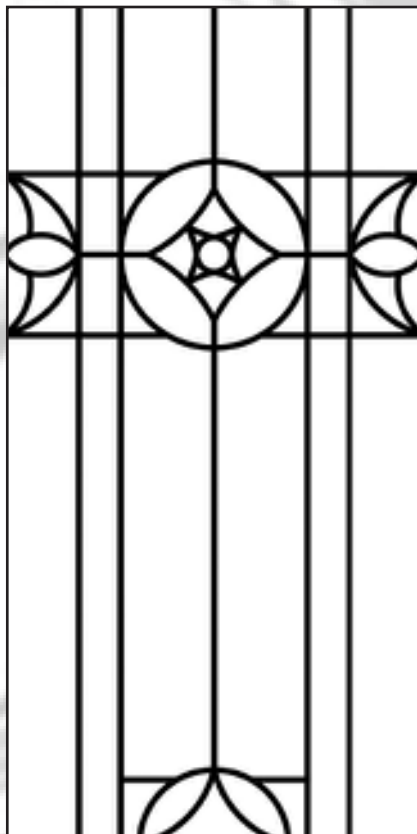

CABT 23

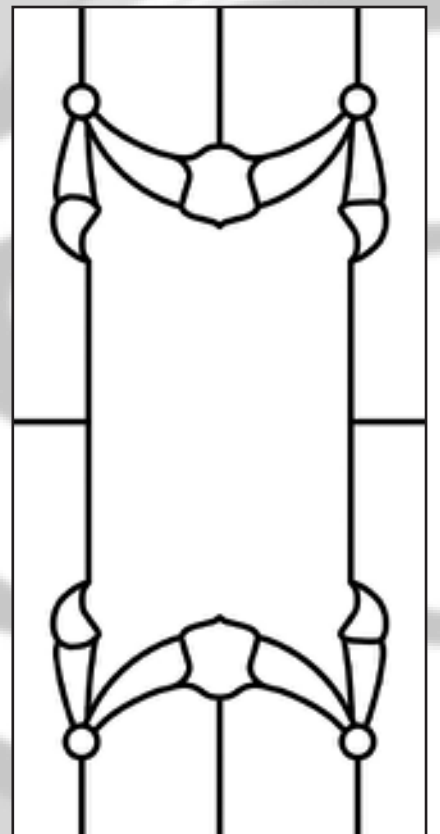

CABT 24

Tradicionales

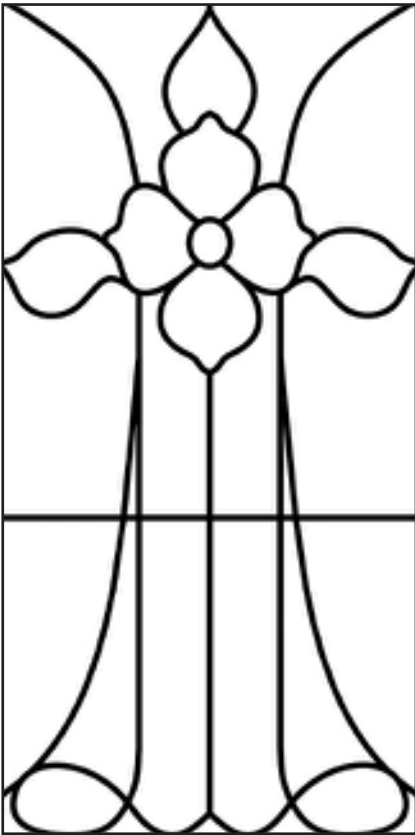

CABT 25

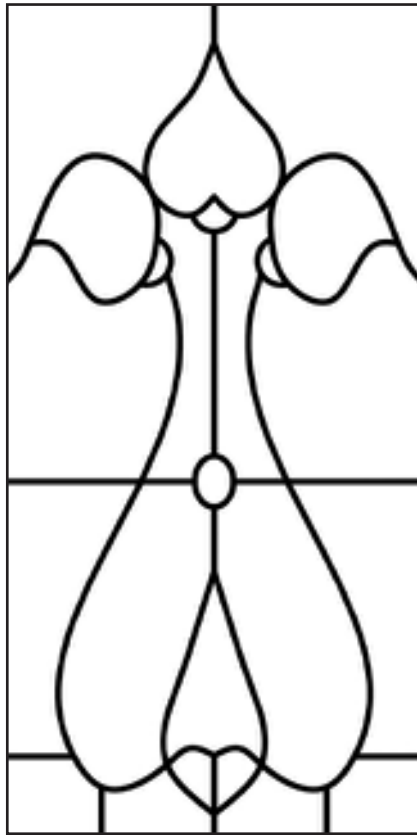

CABT 26

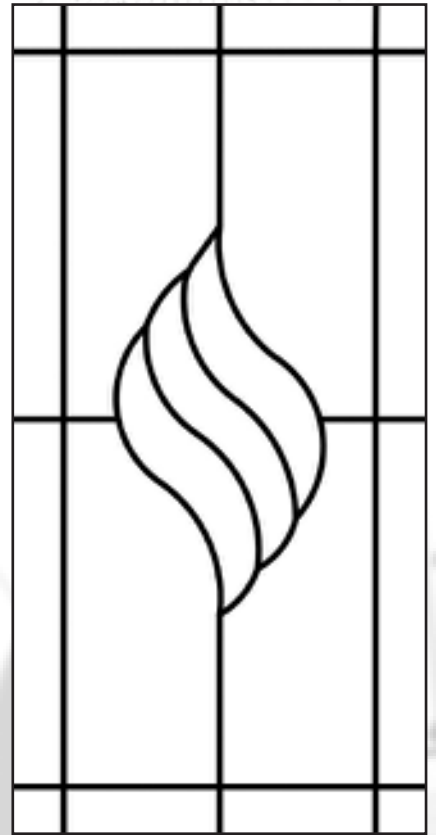

CABT 27



CABT 28

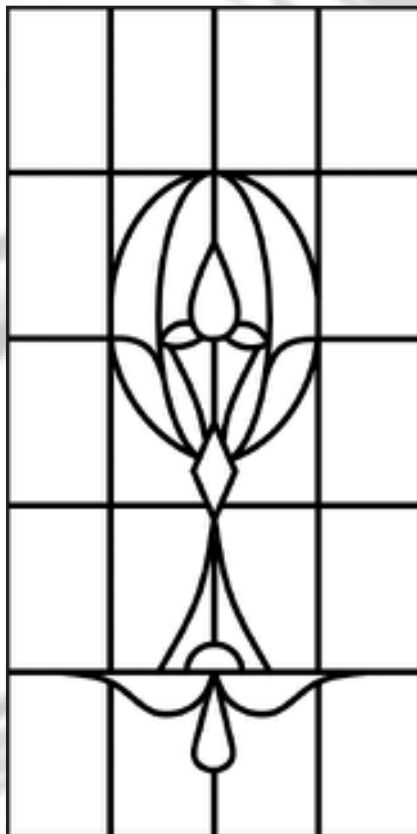

CABT 29

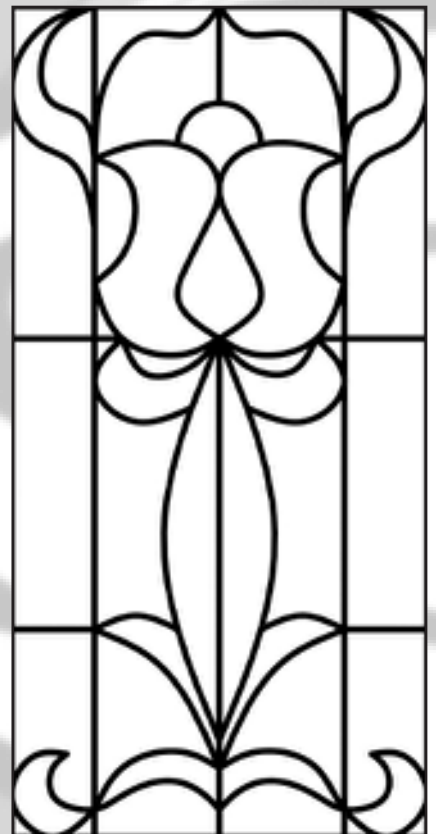

CABT 30

Cocinas

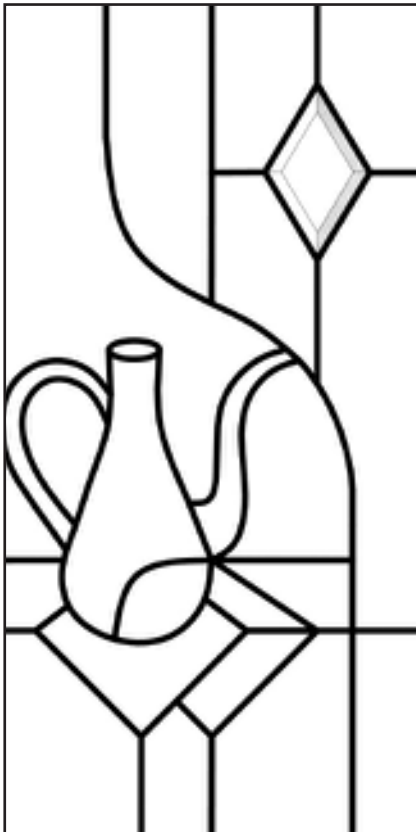

CABKT 01



CABKT 02

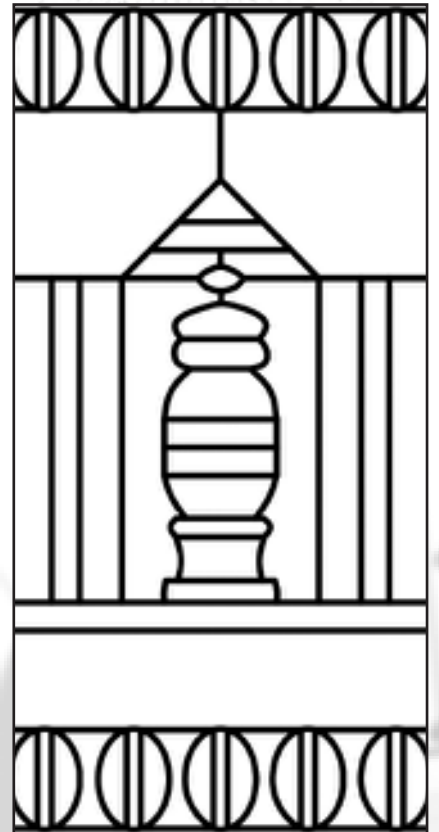

CABKT 03



CABKT 04



CABKT 05

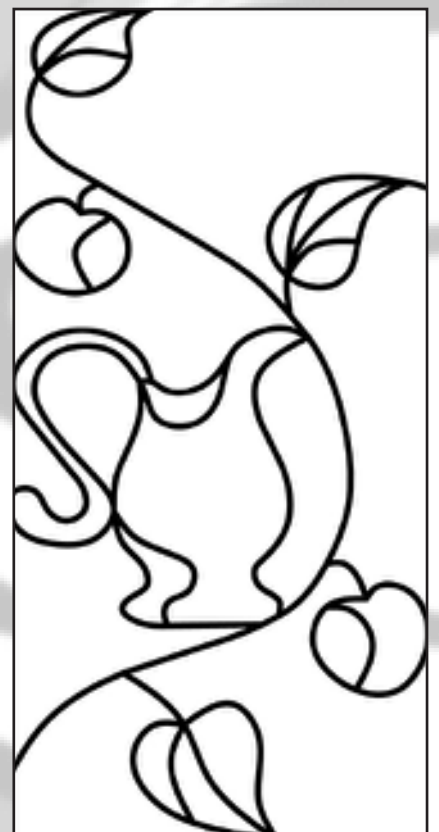

CABKT 06

Grabados y con Plomo

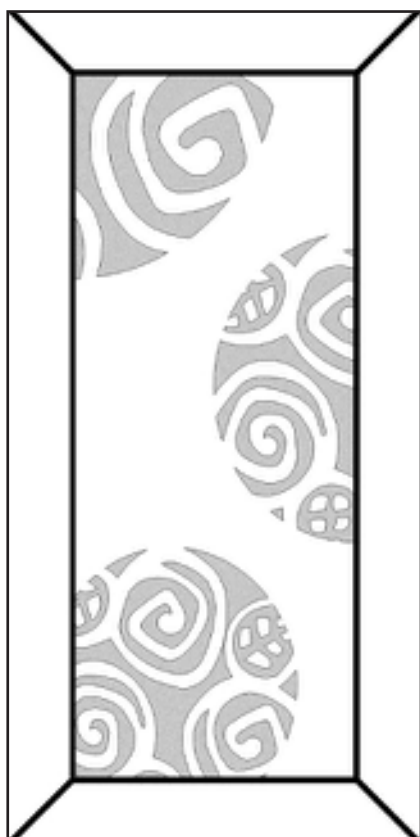

CABET 01



CABET 02

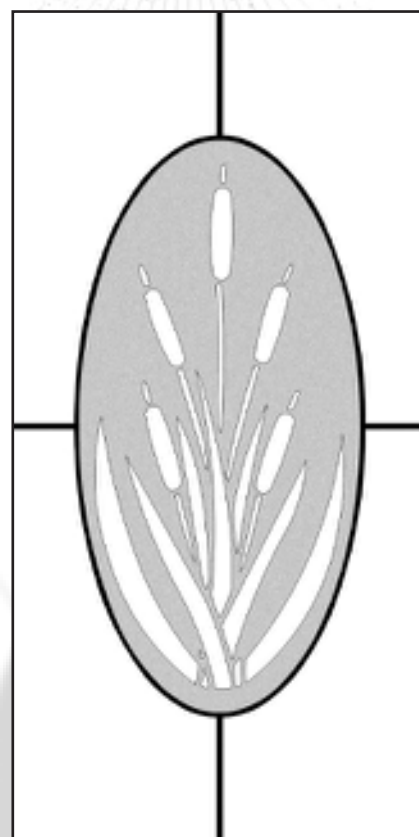

CABET 03

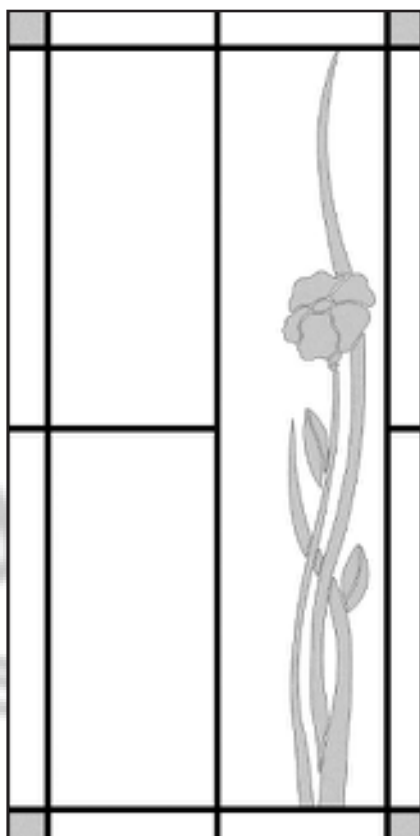

CABET 04

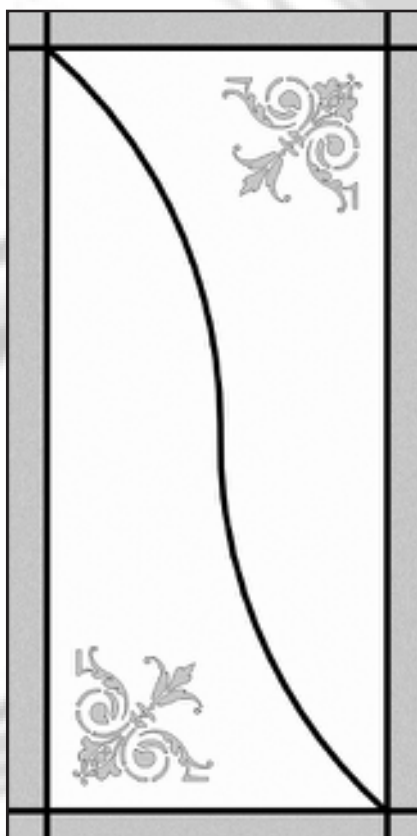

CABET 05

Los efectos de vidrio grabado son particularmente populares en las lastras de cocina y de muebles y ofrecen vidrio decorativo con detalles sin el uso de cualquier color. En esta gama de diseños hemos incorporado el vidrio grabado, perfiles de plomo y nuestra gama de películas de Efecto de Textura de Vidrio para crear efectos de textura múltiple pero de color neutral. Sin embargo, si se desea el color es posible en algunos diseños.



Diseños de Vidrio Biselado

El uso de piezas y agrupaciones de vidrio biselado en el diseño añade una dimensión más al diseño de vidrio decorativo. Los biselados de vidrio de 5 mm de espesor, hechos a mano, brillarán en el diseño mientras la luz se refracta y se refleja a través del extremo biselado.

La gama de 78 diseños que se muestra en las 13 páginas siguientes incorpora una amplia gama de estilos, desde la elegancia clásica de los Diseños Sencillos de Biselado al detalle asombroso de la Colección de Diseñadores con algunos diseños interesantes y menos usuales como las escrituras chinas inspiradoras y el diseño hermoso de palometa que se muestran en la página 42.

CABBEV 45

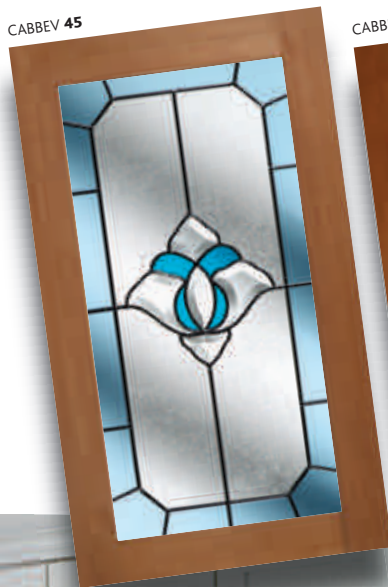

CABBEV 41



CABJEW 02

Todos los 78 diseños que se muestran en las 13 páginas siguientes se diseñaron con el uso de piezas o agrupaciones de vidrio biselado del catálogo de la Colección Definitiva RegaBevel. Además de los diseños que se muestran en este catálogo hay centenares de diseños de biselado alternativos disponibles.

Muchas de las piezas y las agrupaciones de biselados que se muestran en estos diseños son disponibles en una variedad de colores o texturas para clientes que buscan una alternativa a las opciones de costumbre de vidrio transparente. Las opciones de colores incluyen azul, bronce, verde y gris y algunos biselados son disponibles en el acabado de Piezas de Pega o el nuevo Dicroico que cambia de color cuando se mira el vidrio desde ángulos distintos. Por favor consulte a su suministrador en cuanto a la disponibilidad.

Diseños Biselados Sencillos

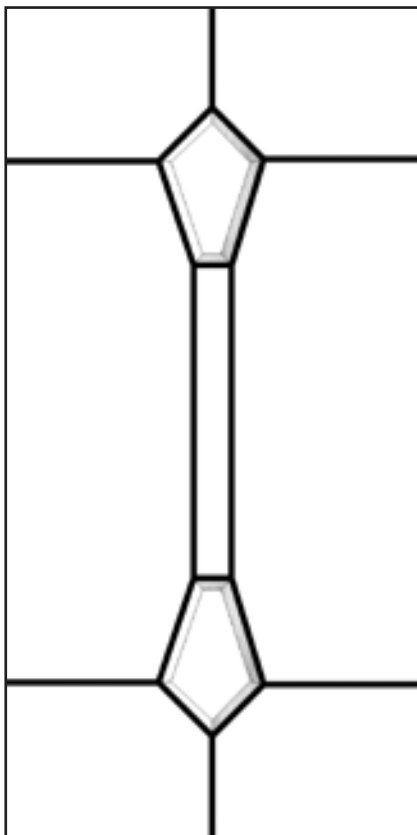

CABBEV 01

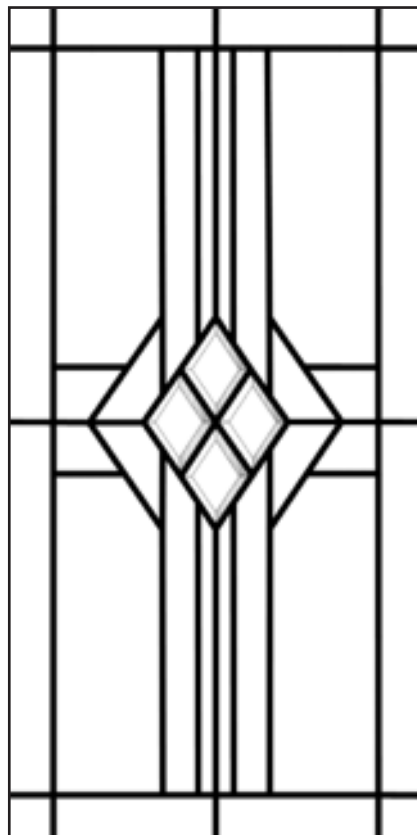

CABBEV 02

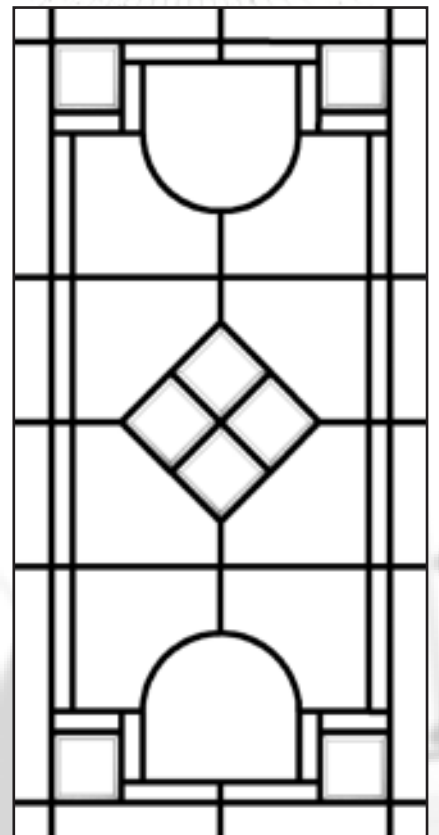

CABBEV 03

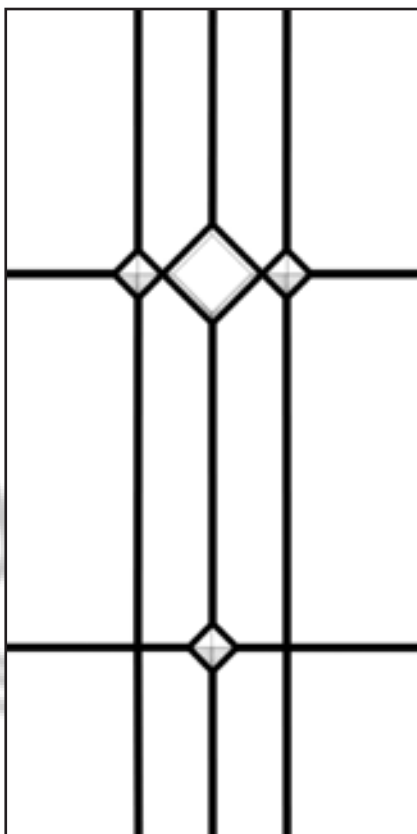

CABBEV 04

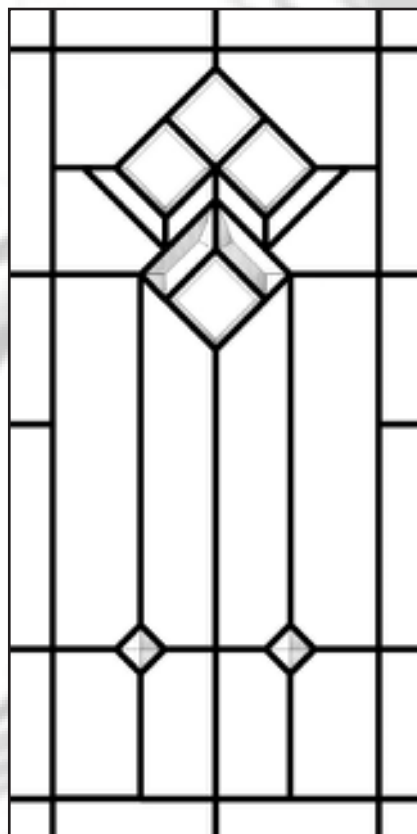

CABBEV 05

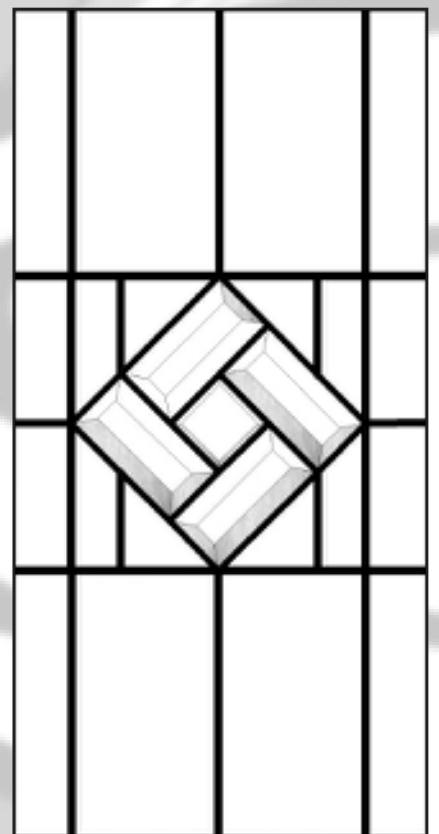

CABBEV 06

Diseños Biselados Sencillos

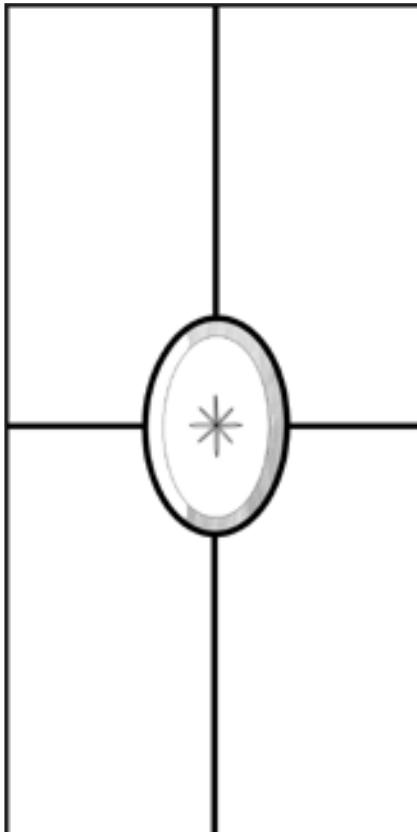

CABBEV 07

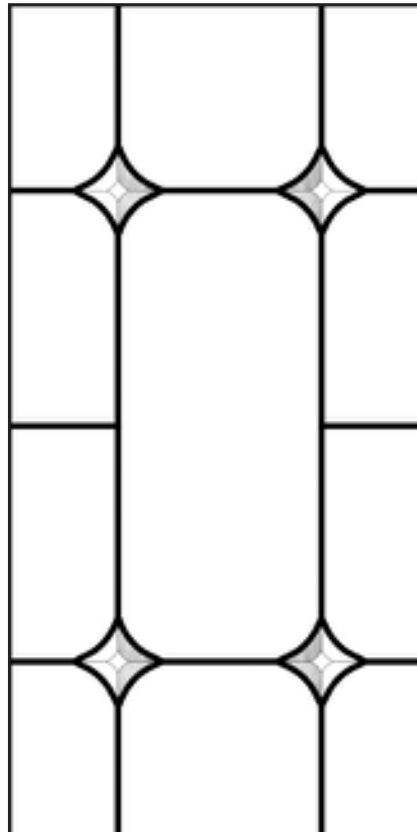

CABBEV 08

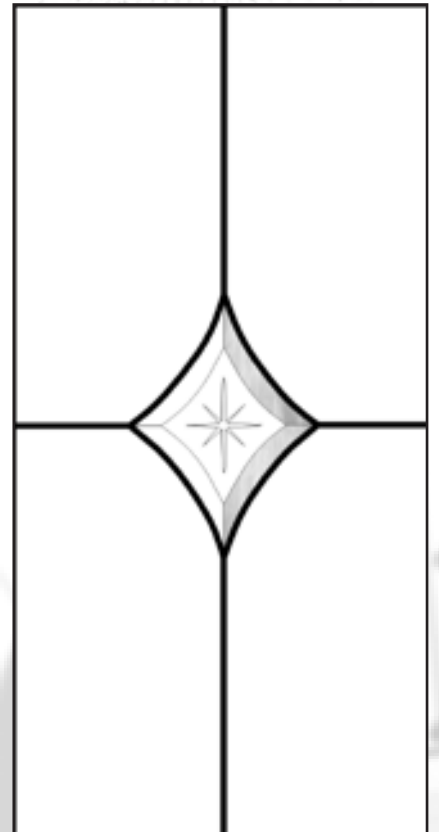

CABBEV 09

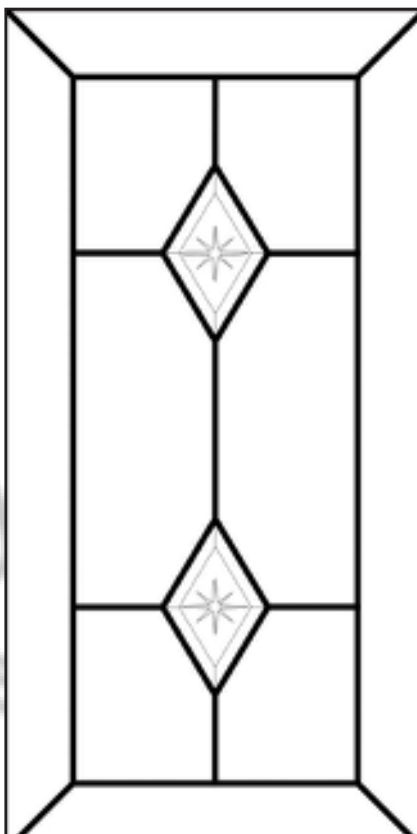

CABBEV 10

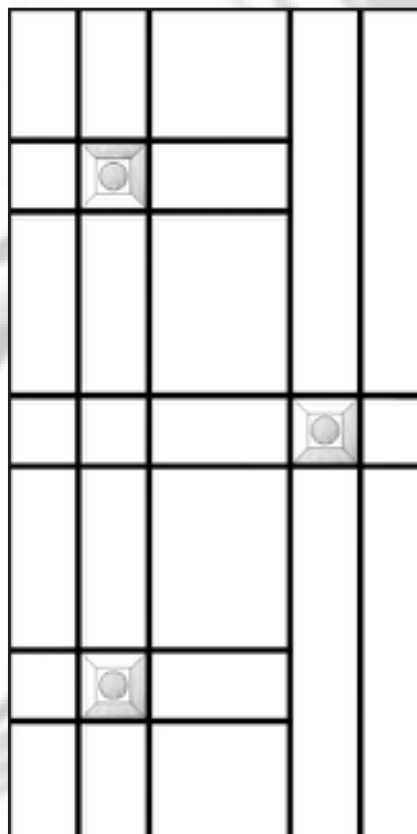

CABBEV 11

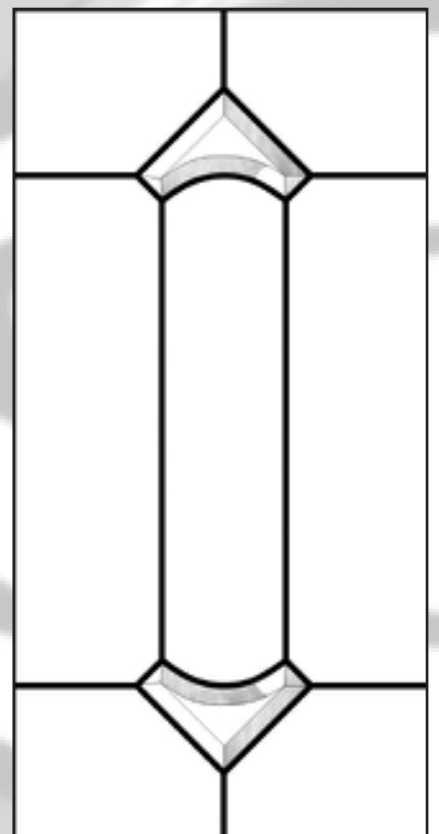

CABBEV 12

Diseños Biselados Sencillos

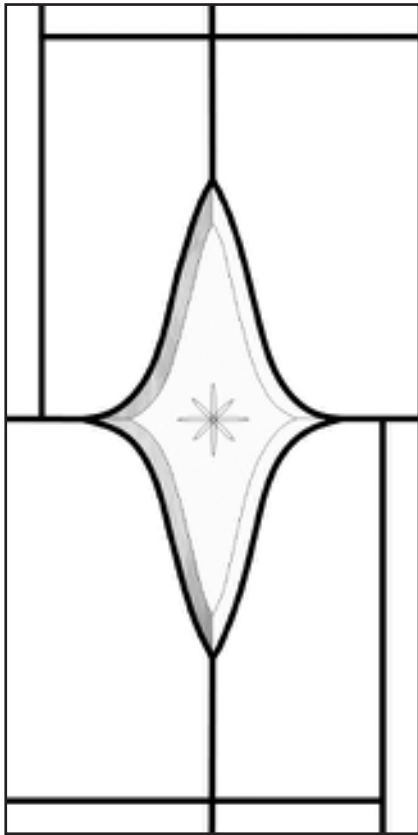

CABBEV 13

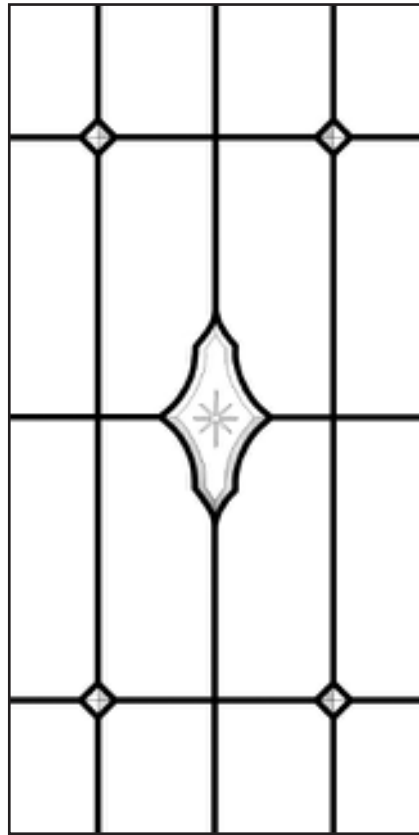

CABBEV 14

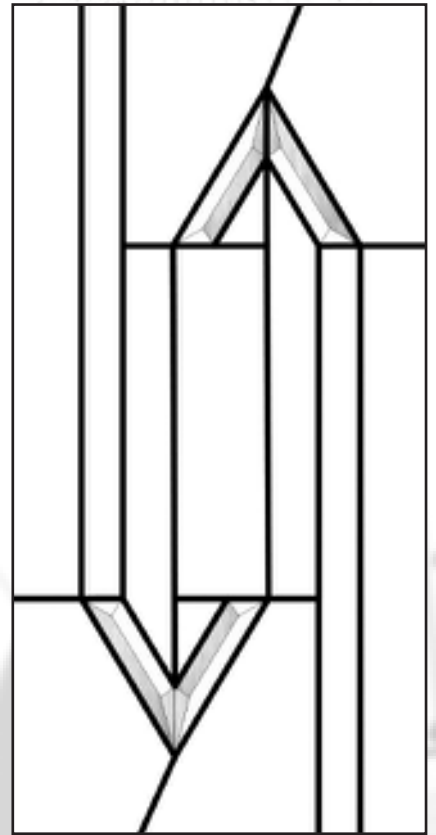

CABBEV 15

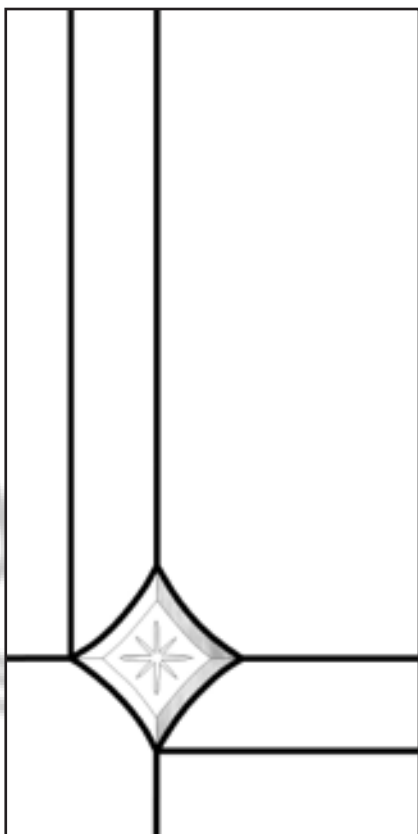

CABBEV 16

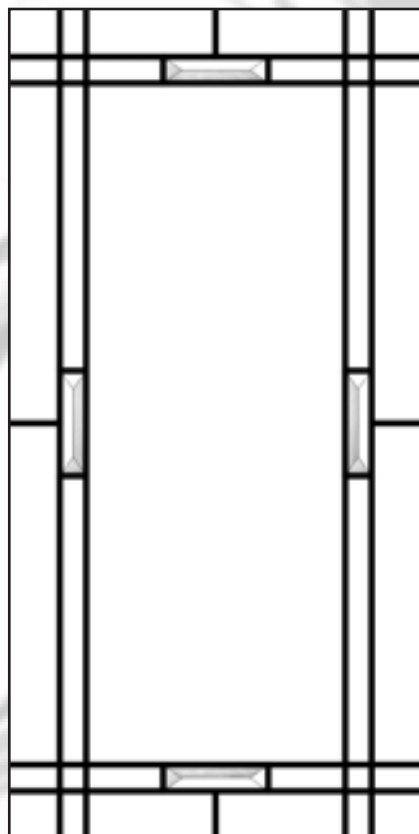

CABBEV 17

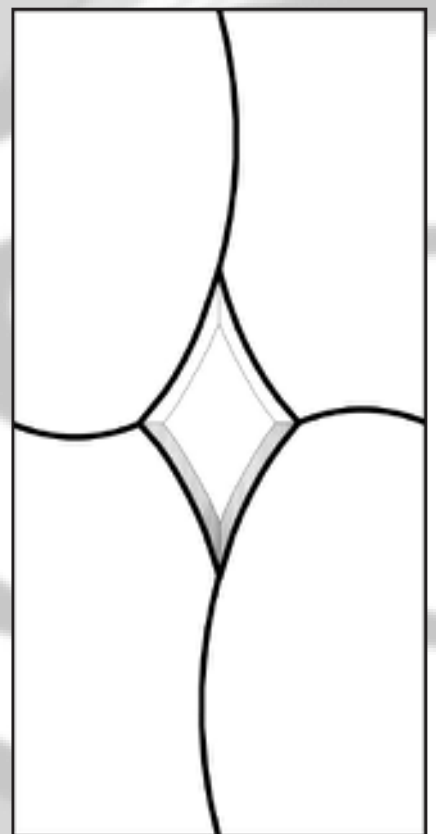

CABBEV 18

Colección de Diseñadores

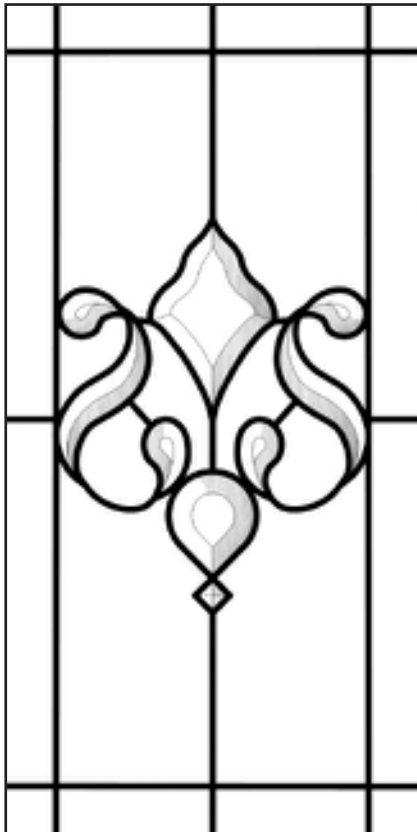

CABBEV 19

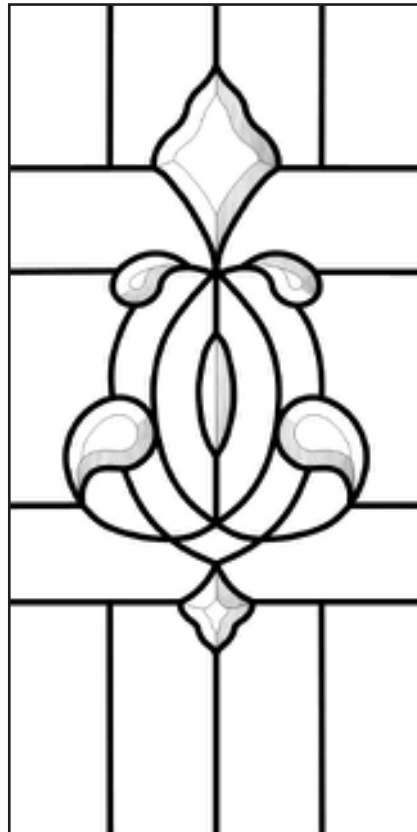

CABBEV 20

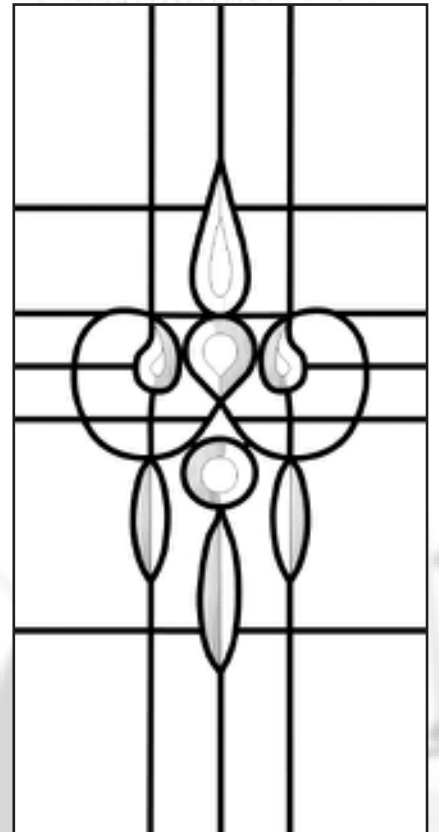

CABBEV 21

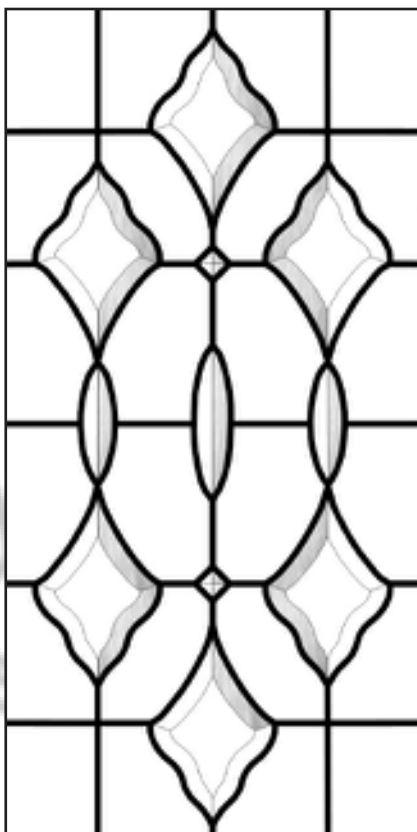

CABBEV 22

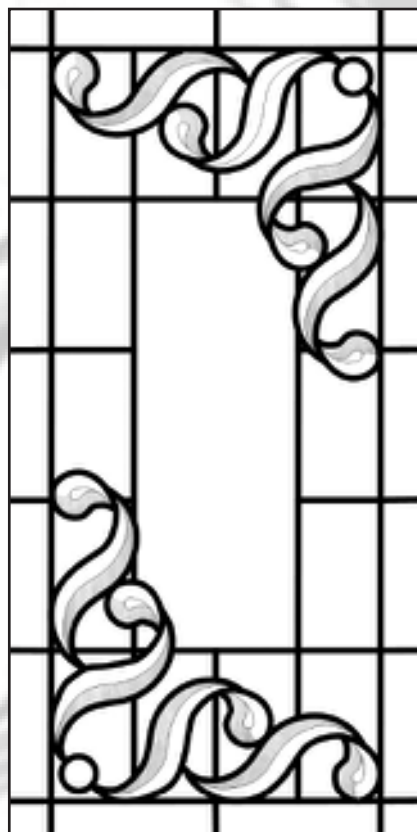

CABBEV 23

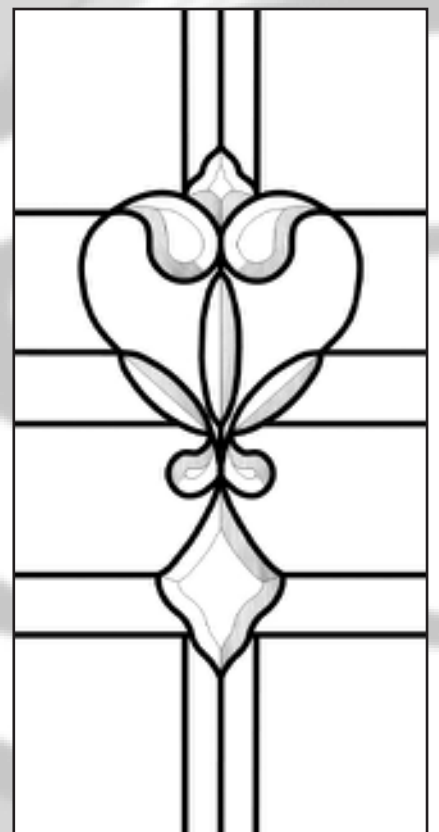

CABBEV 24

Colección de Diseñadores

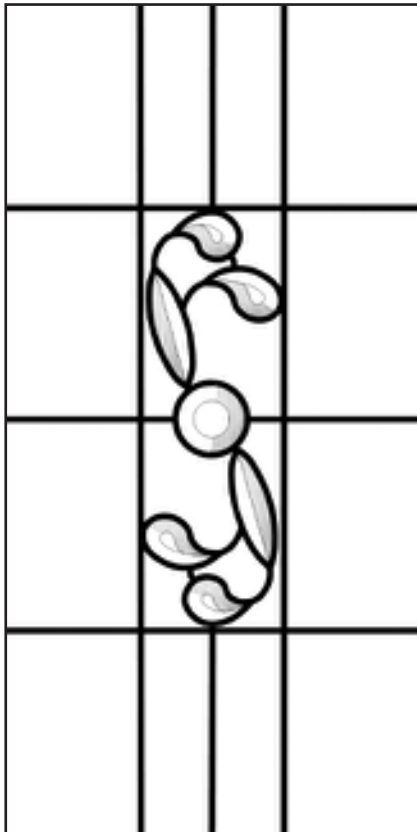

CABBEV 25

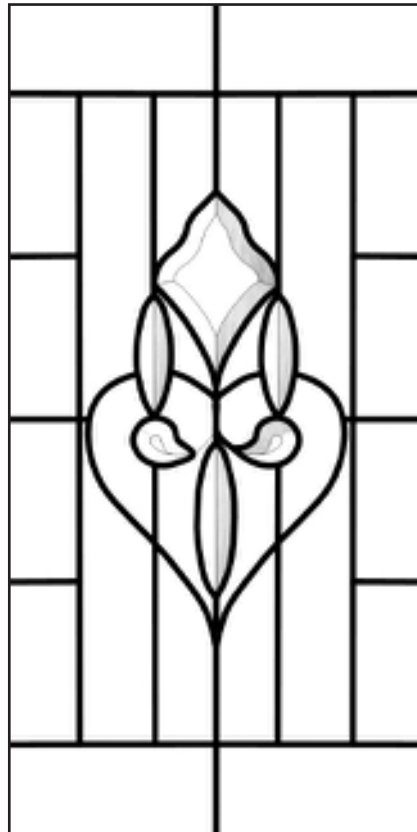

CABBEV 26

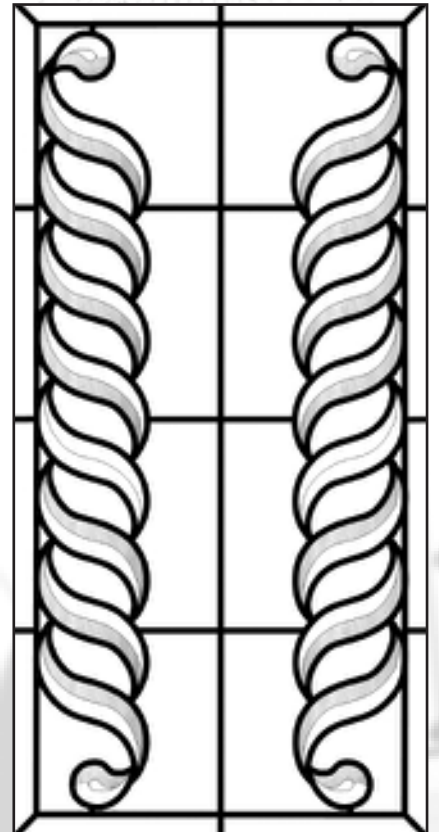

CABBEV 27

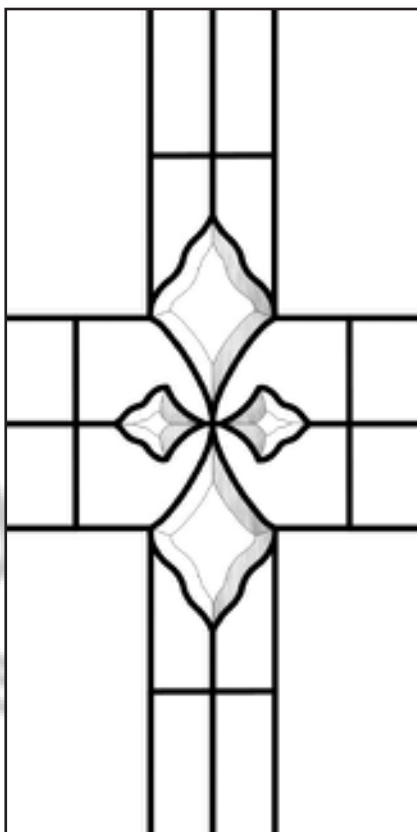

CABBEV 28

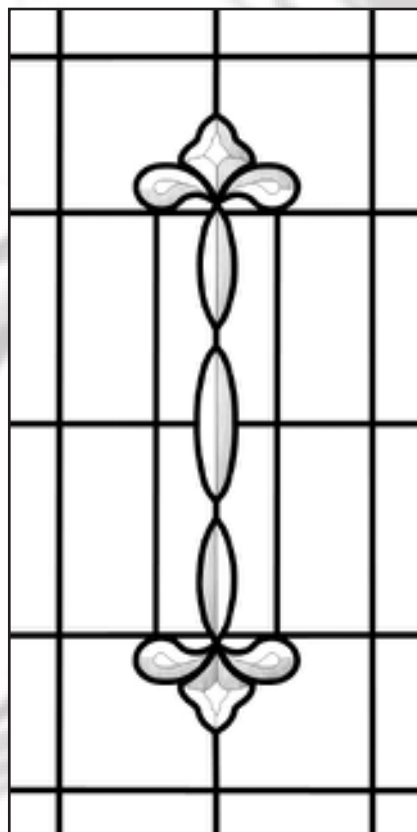

CABBEV 29

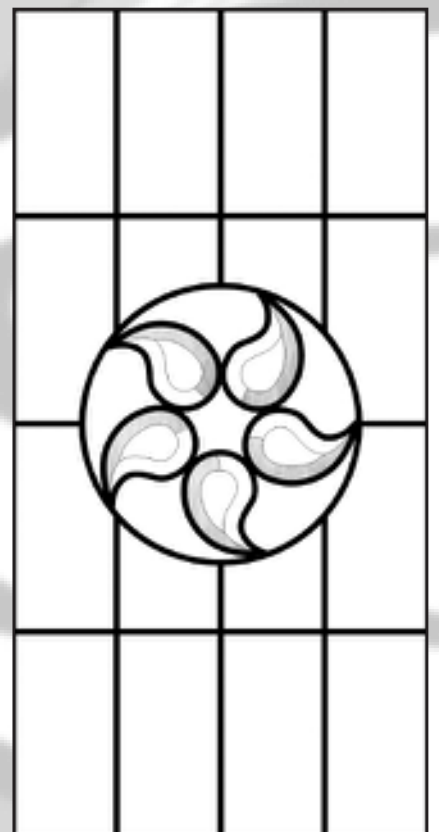

CABBEV 30

Agrupaciones de Biselados

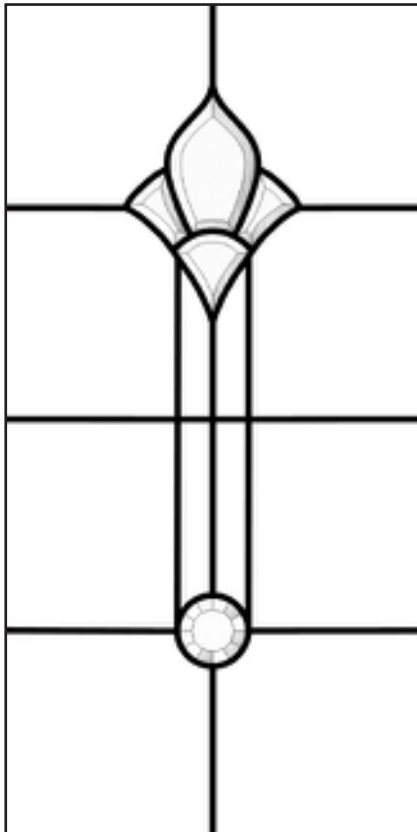

CABBEV 31

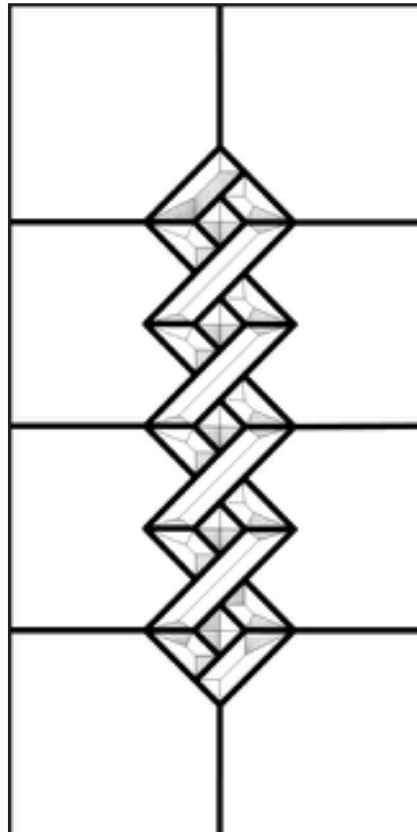

CABBEV 32

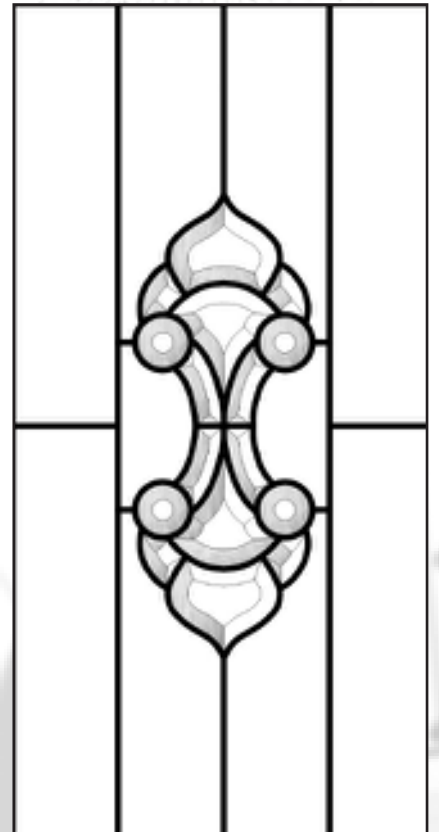

CABBEV 33

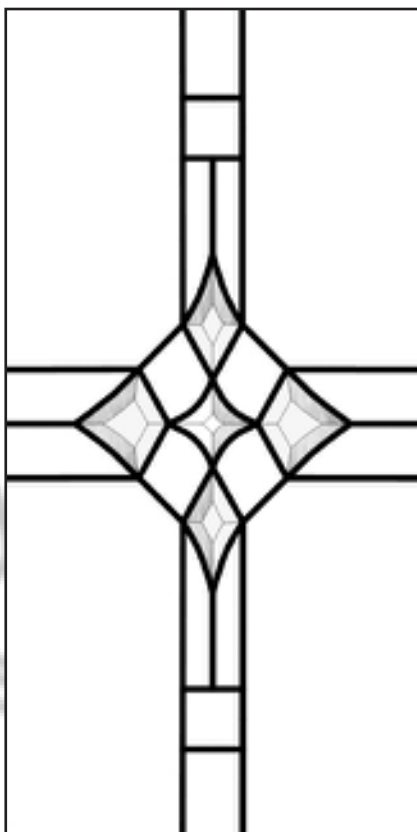

CABBEV 34

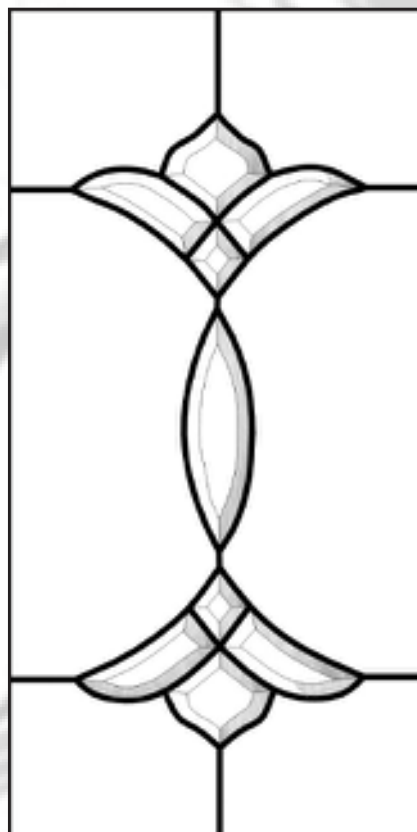

CABBEV 35

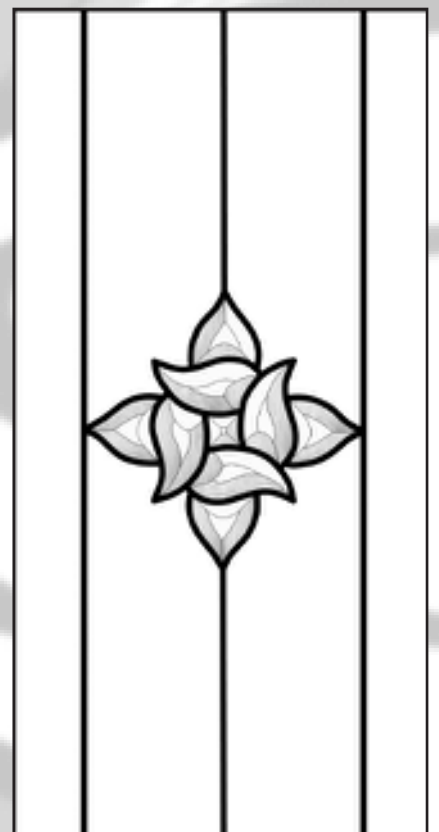

CABBEV 36

Agrupaciones de Biselados

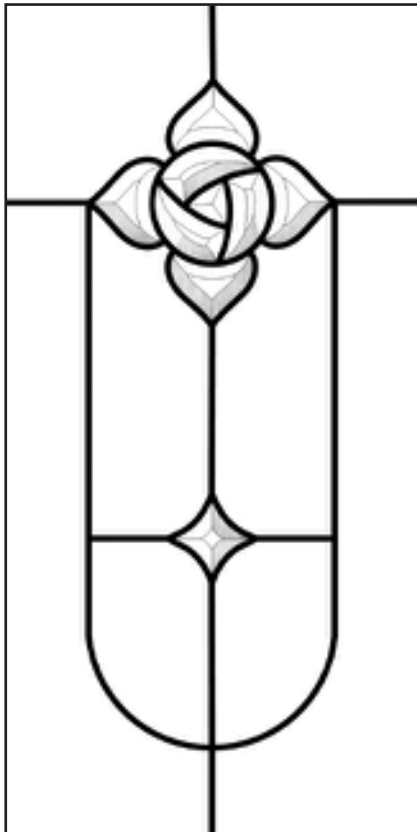

CABBEV 37

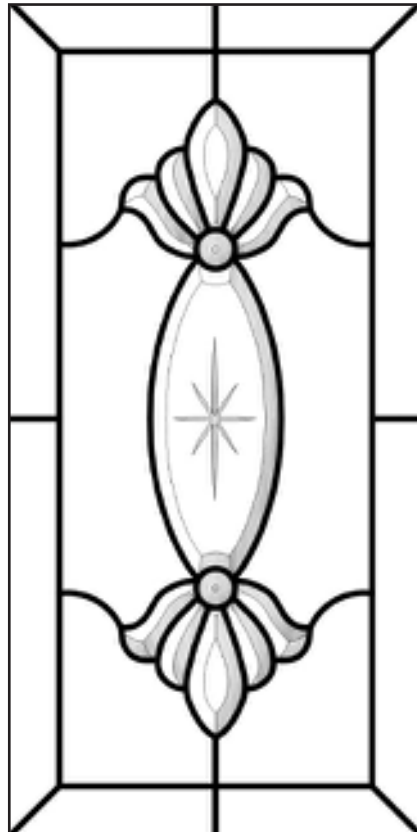

CABBEV 38

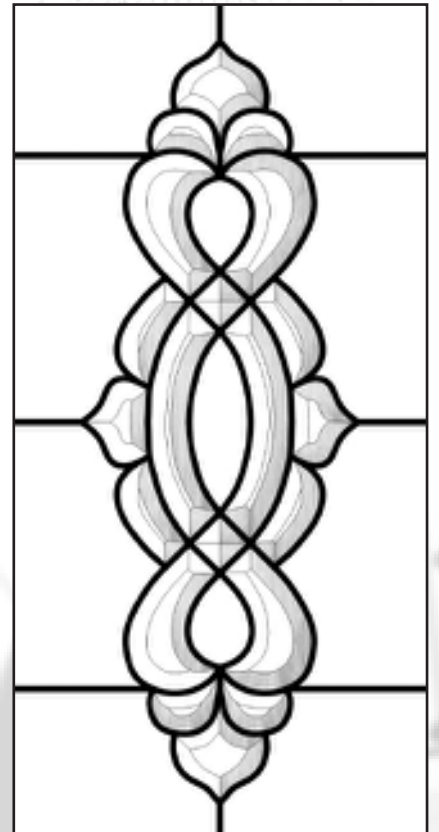

CABBEV 39

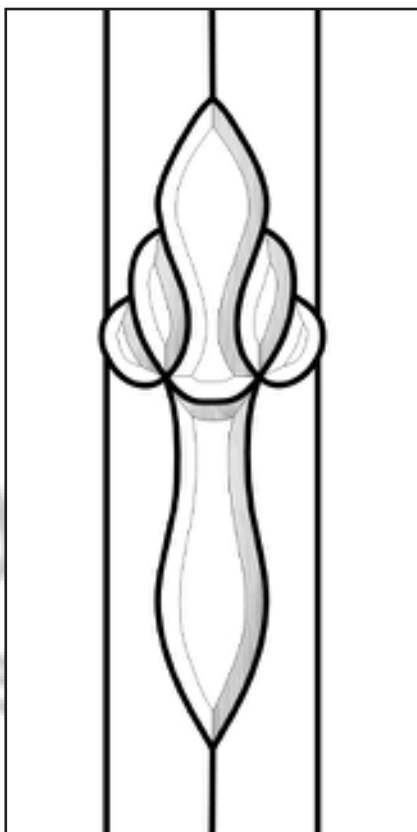

CABBEV 40

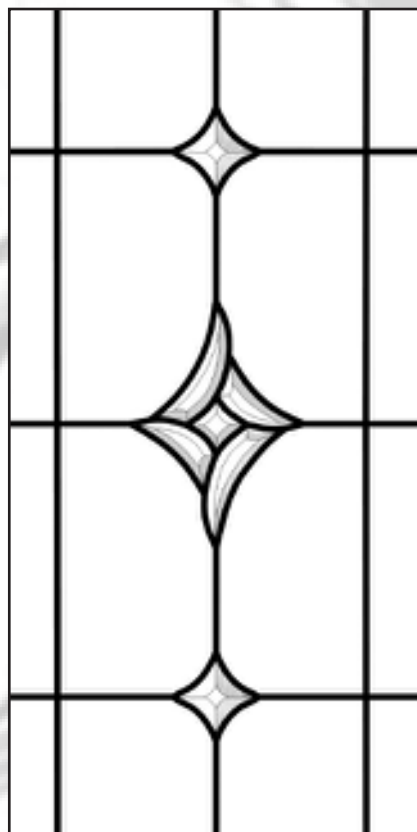

CABBEV 41

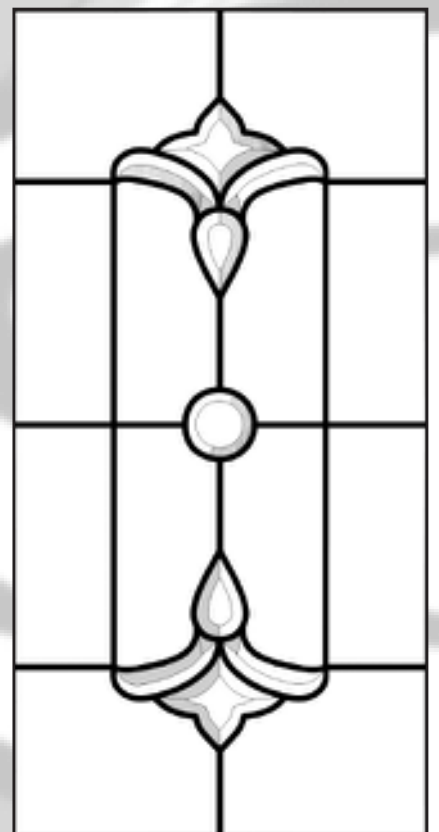

CABBEV 42

Agrupaciones de Biselados

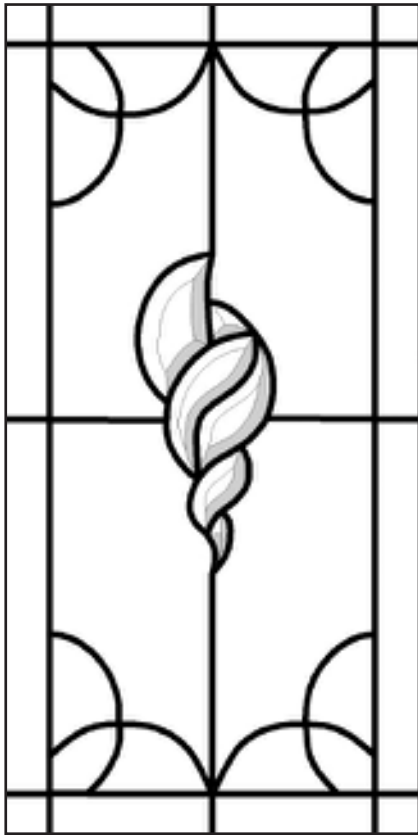

CABBEV 43

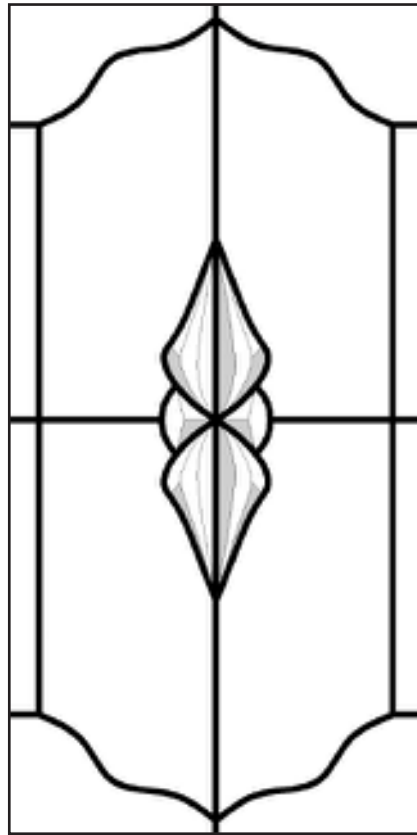

CABBEV 44

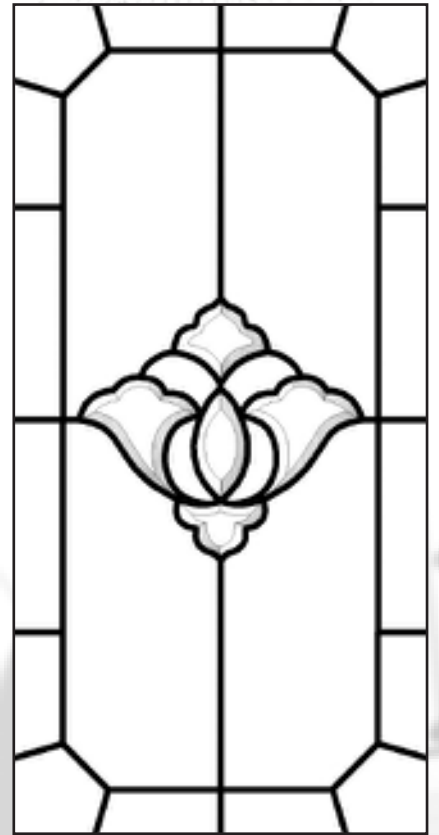

CABBEV 45



CABBEV 46/47

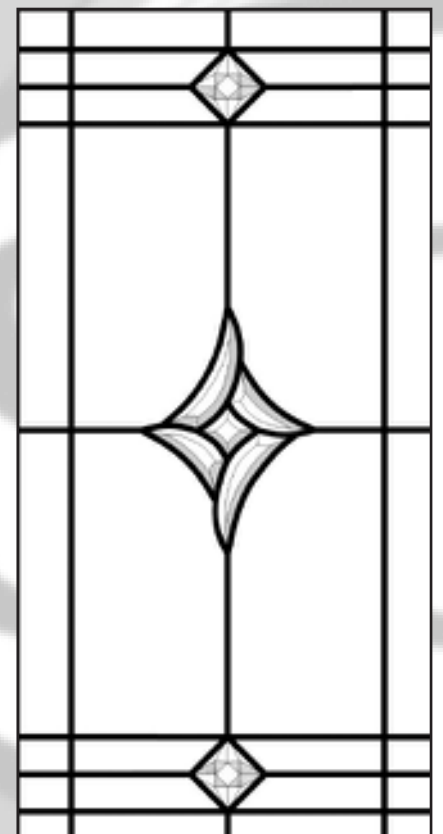
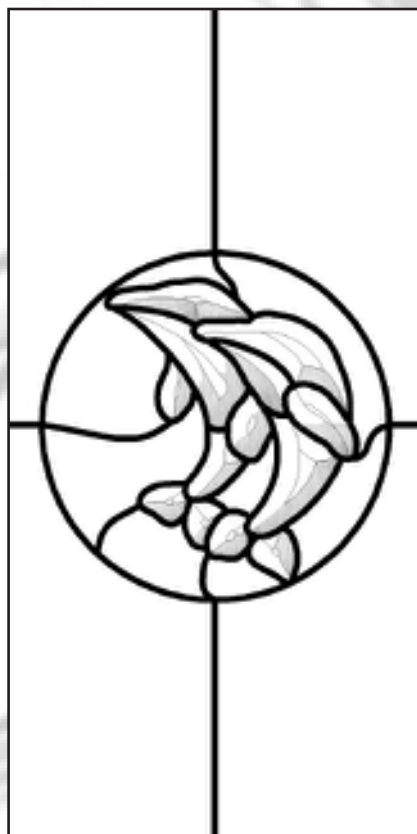

CABBEV 48

Agrupaciones de Biselados



CABBEV 49/50

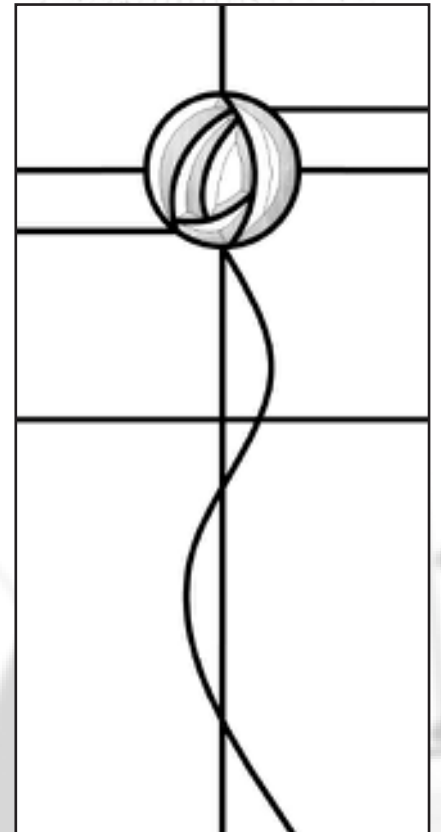
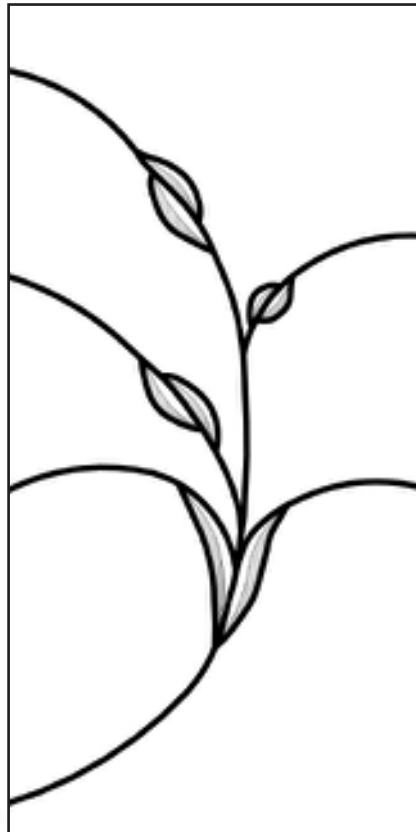

CABBEV 51

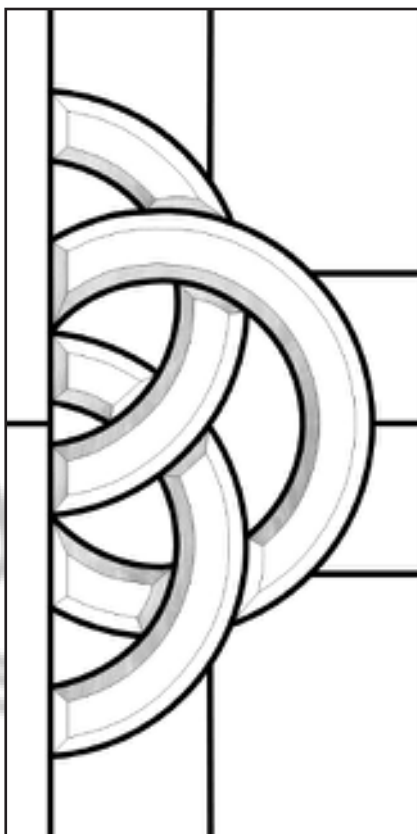

CABBEV 52

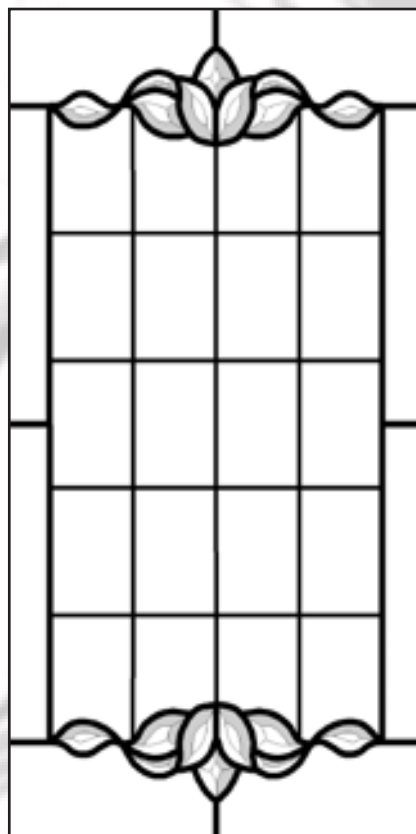

CABBEV 53

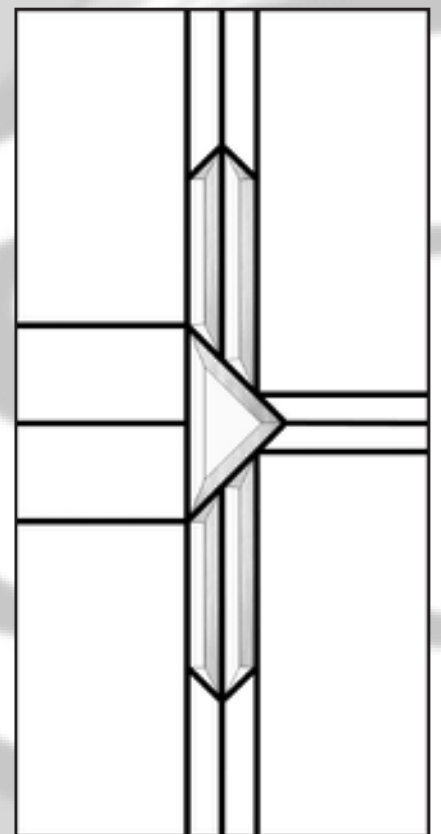

CABBEV 54

Agrupaciones de Biselados



CABBEV 55

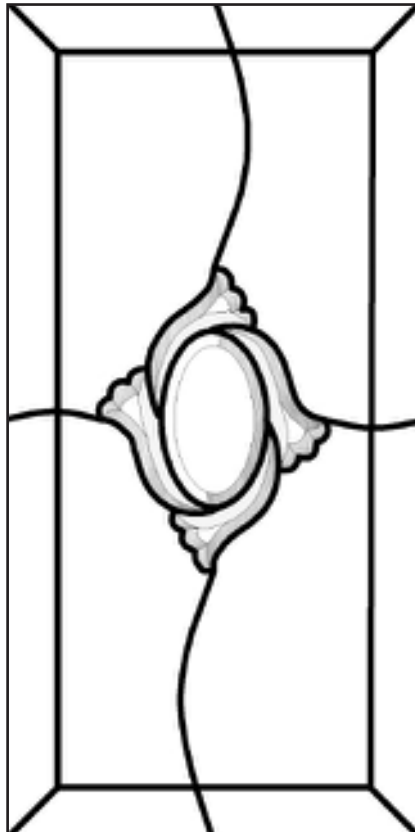

CABBEV 56/57

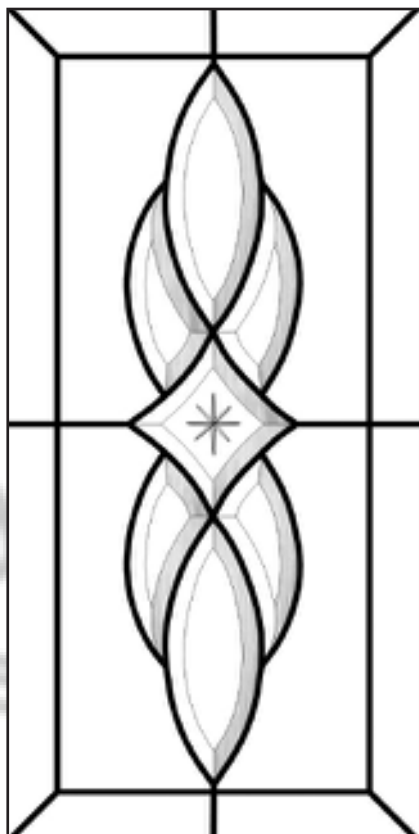
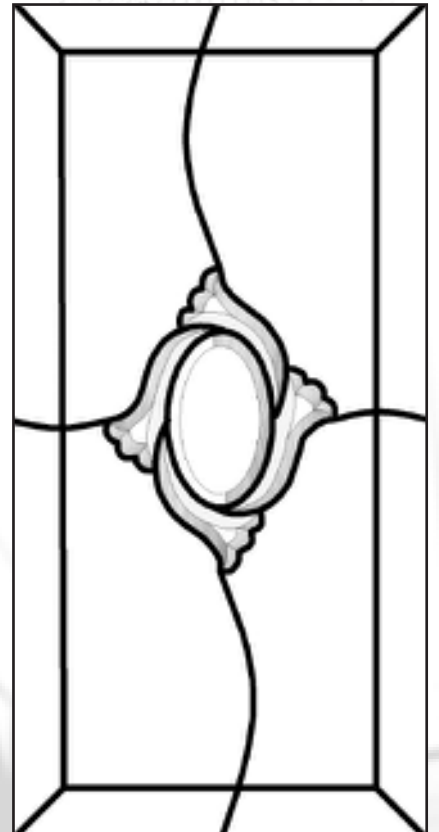

CABBEV 58

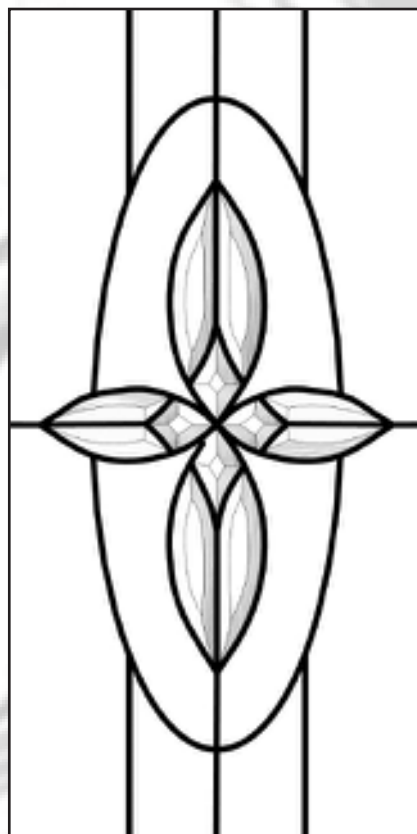

CABBEV 59

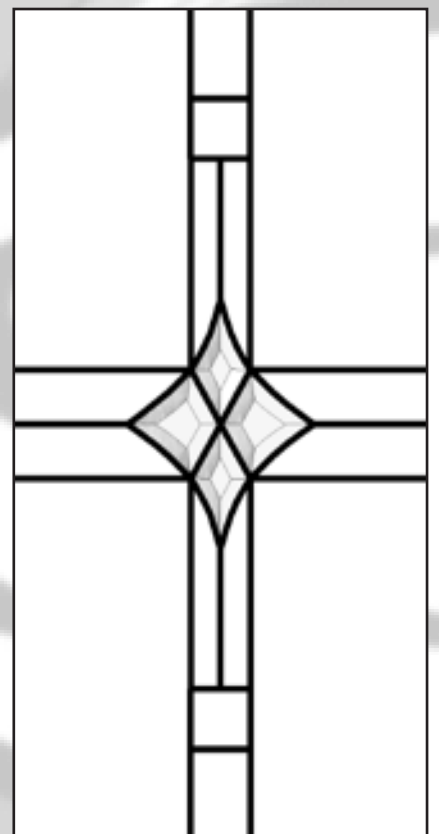

CABBEV 60

Agrupaciones de Biselados

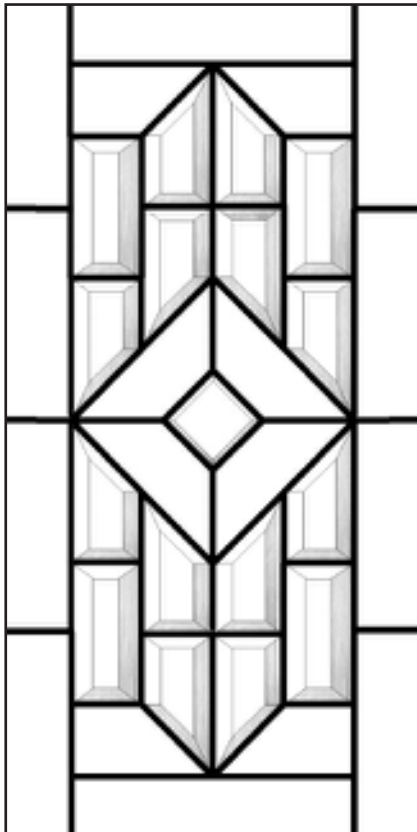

CABBEV 61

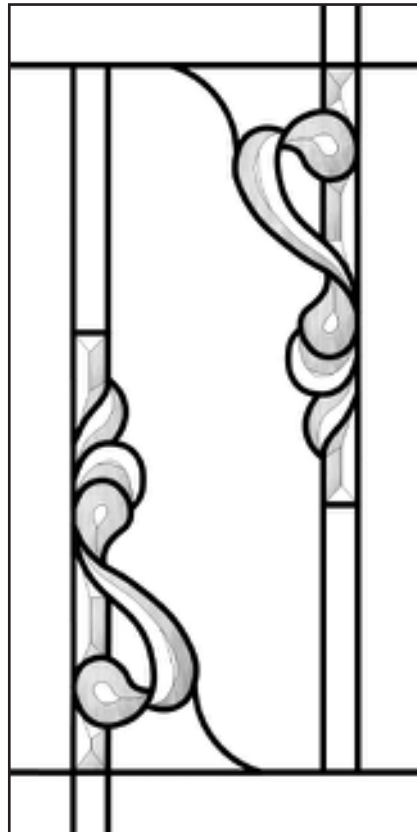

CABBEV 62

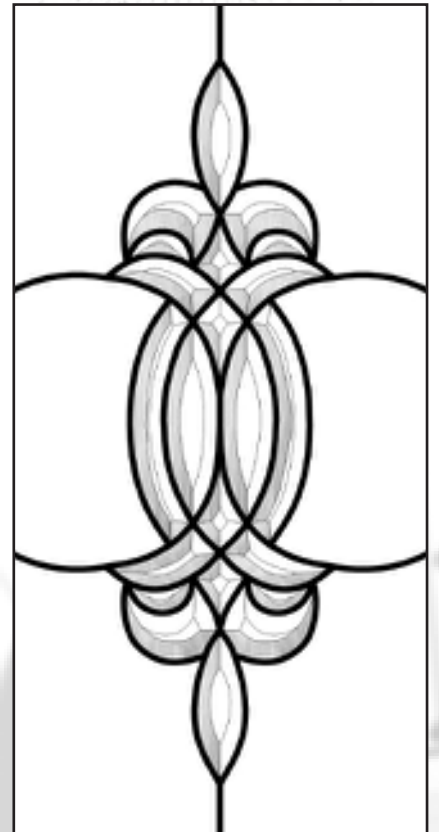

CABBEV 63

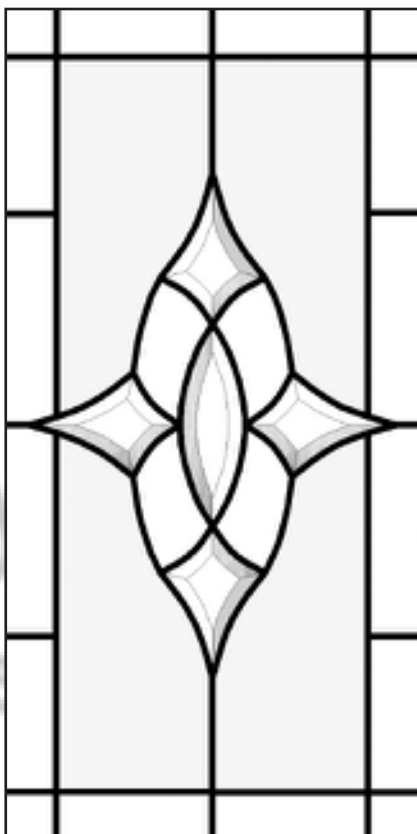

CABBEV 64

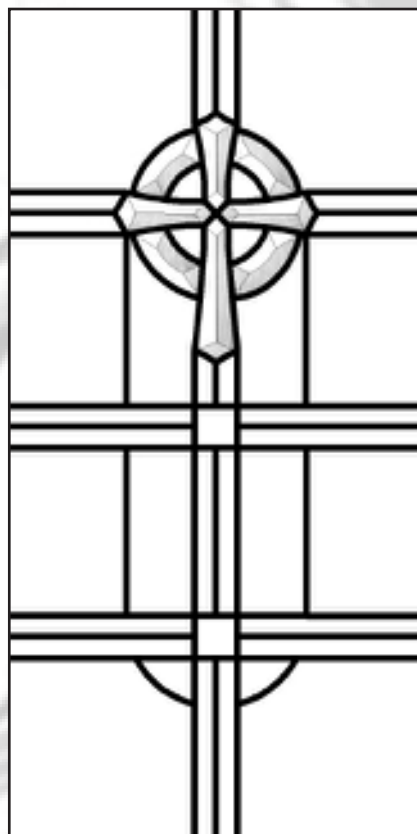

CABBEV 65

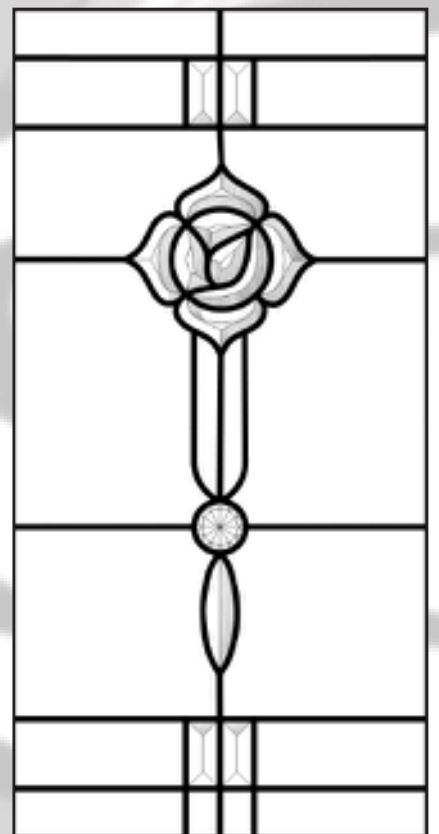

CABBEV 66

Agrupaciones de Biselados

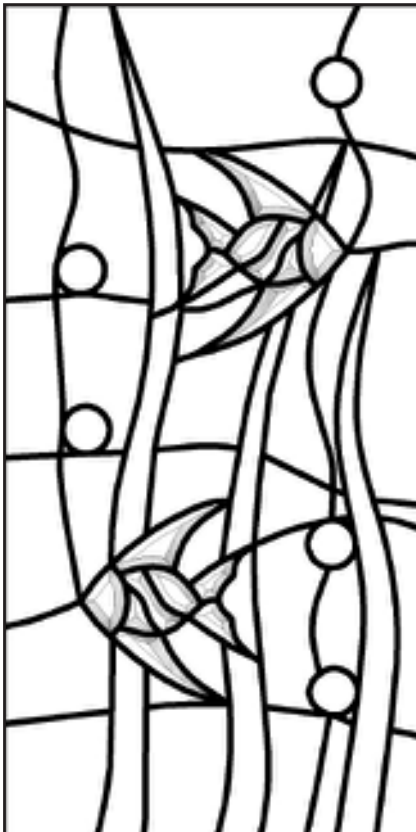

CABBEV 67/68

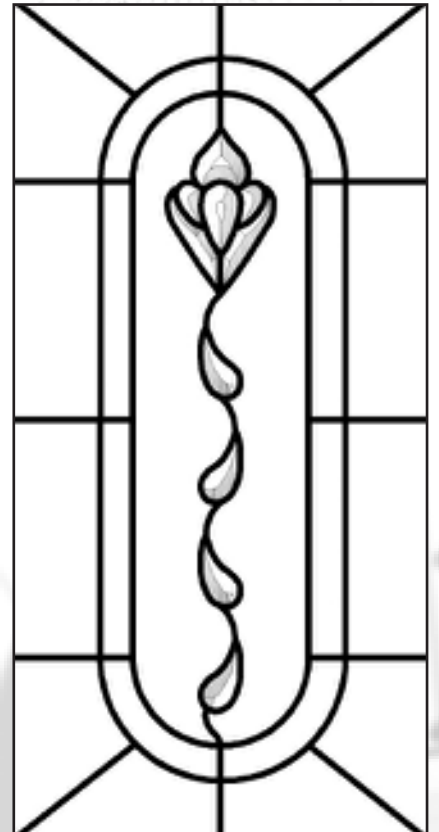

CABBEV 69



CABBEV 70 (*Live Long*)



CABBEV 71 (*Happiness*)

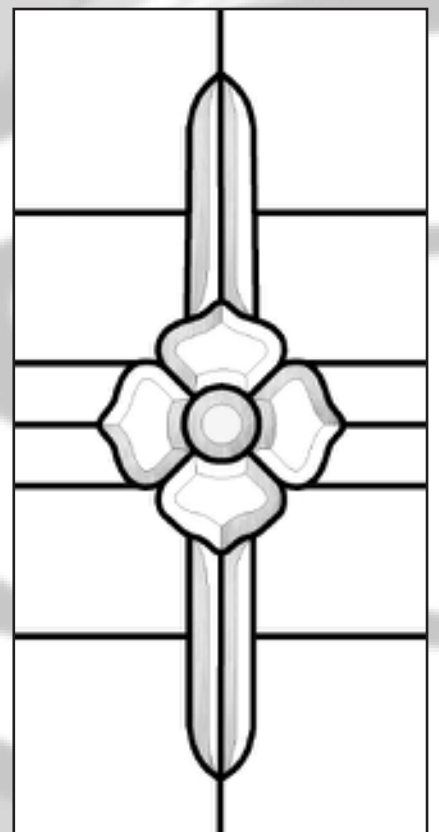

CABBEV 72

Biselados de Rincón

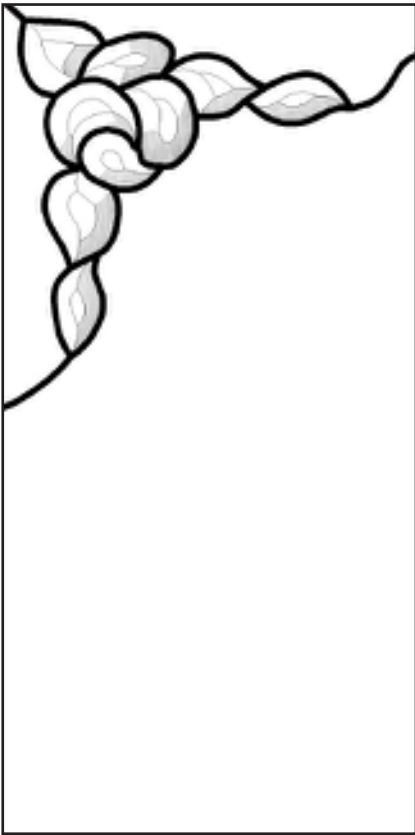

CABBEV 73



CABBEV 74

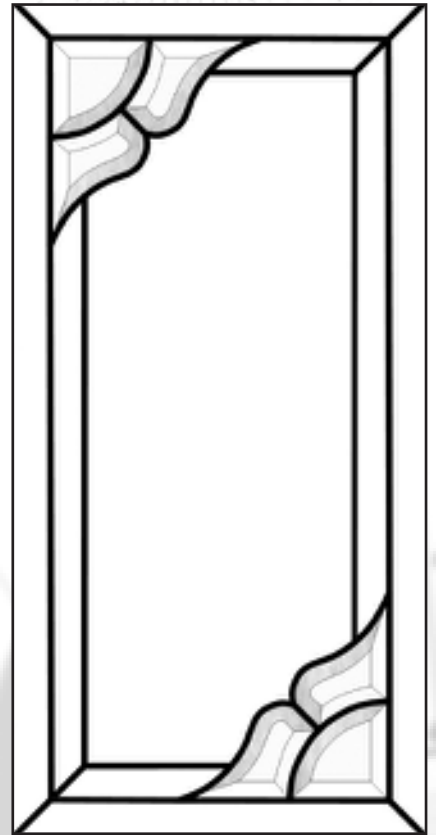

CABBEV 75



CABBEV 76

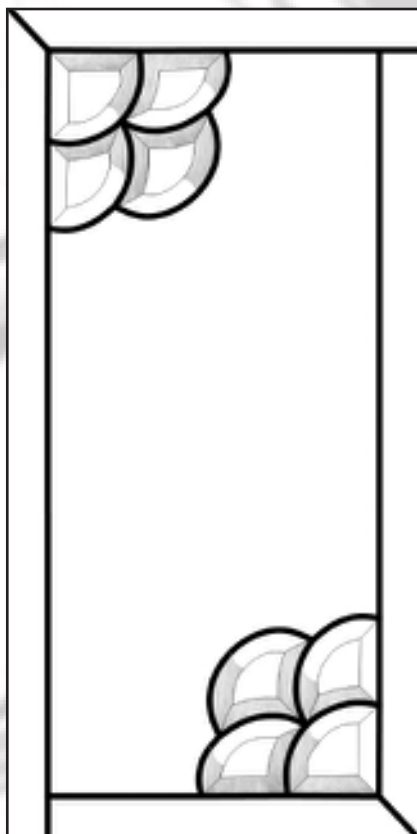

CABBEV 77

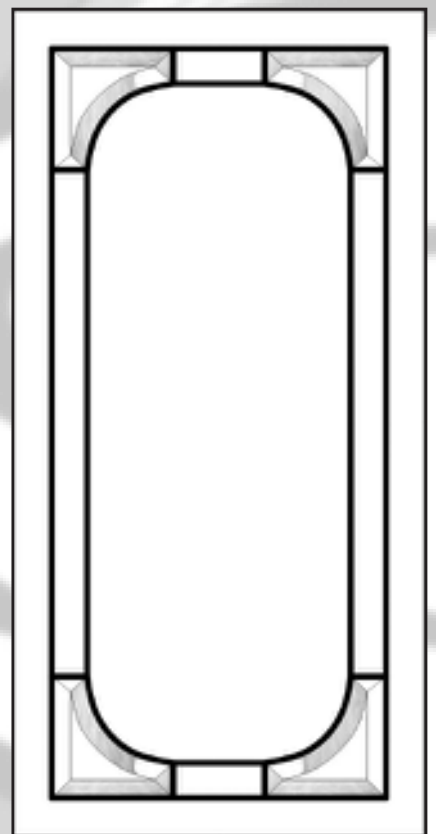

CABBEV 78

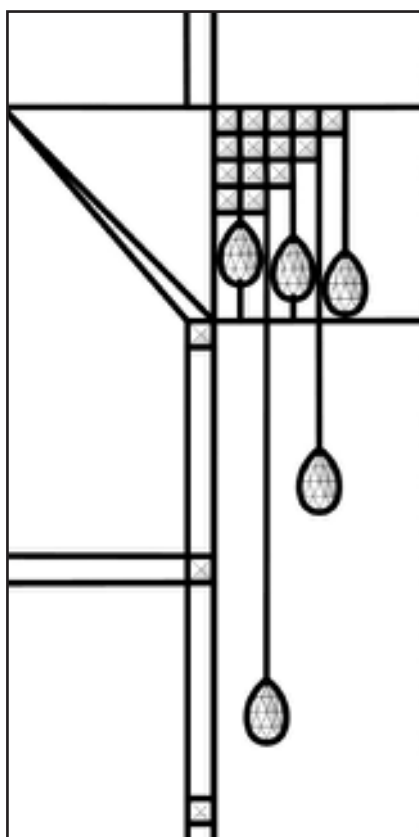

CABJEW 01/02

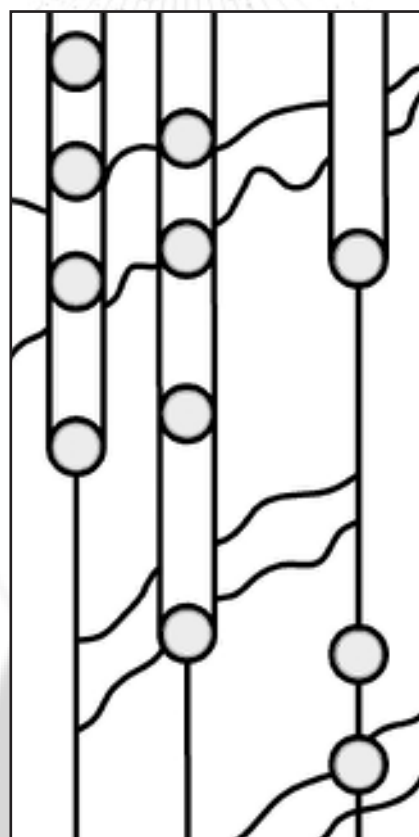
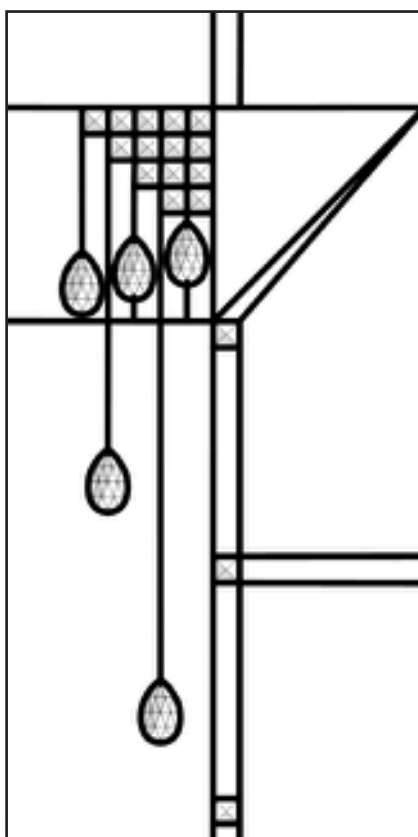

CABJEW 03

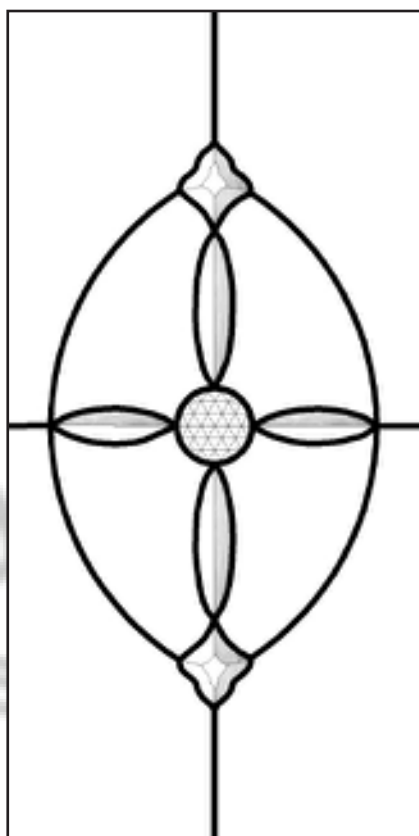

CABJEW 04

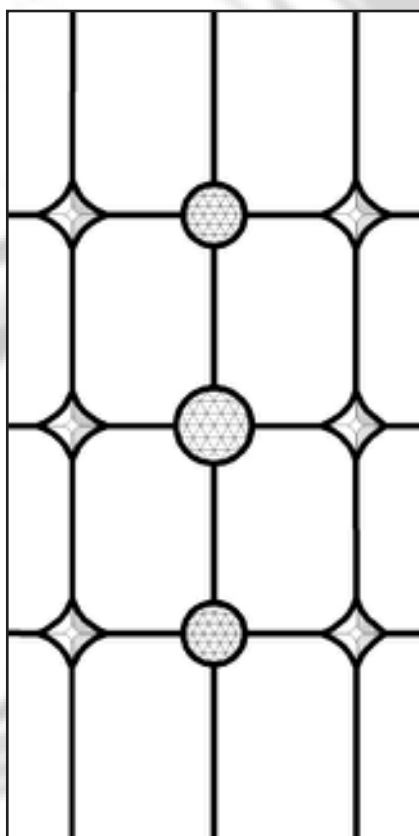

CABJEW 05

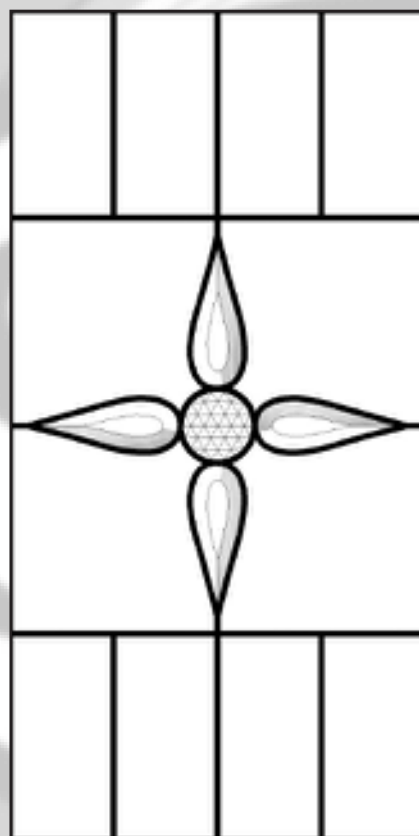

CABJEW 06

Joyas

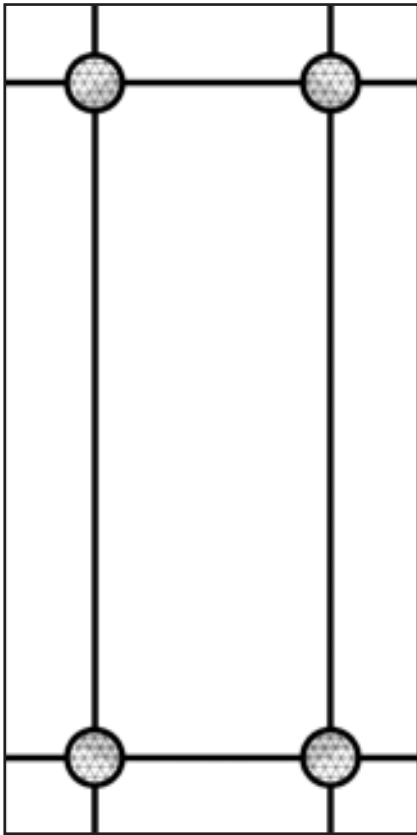

CABJEW 07



CABJEW 08

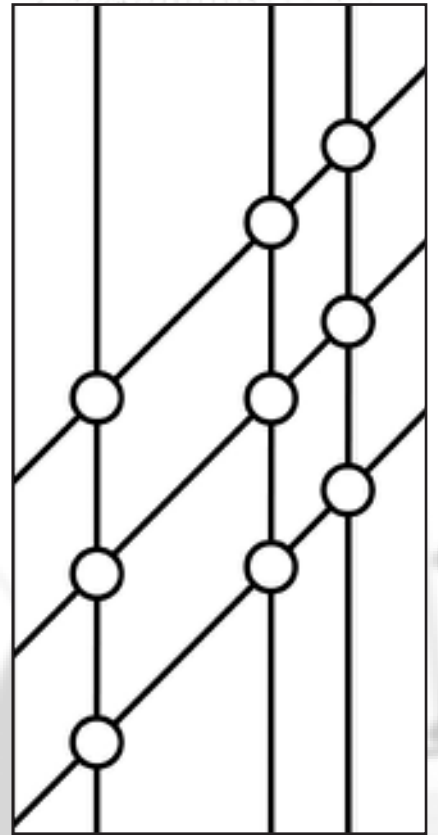

CABJEW 09

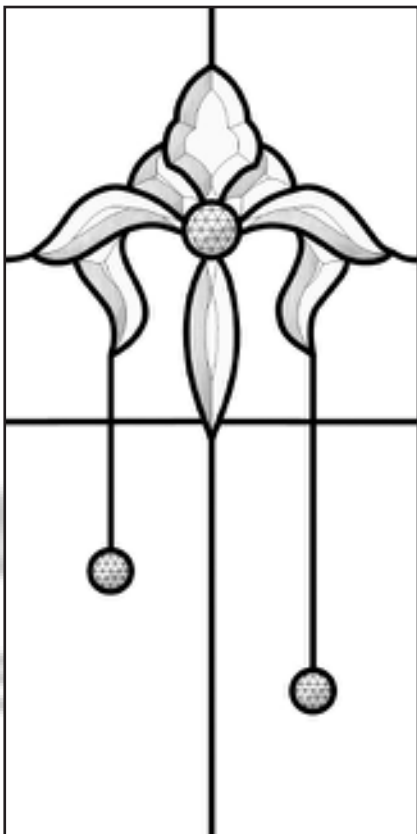

CABJEW 10



Transparente

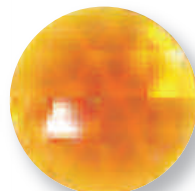

Ámbar

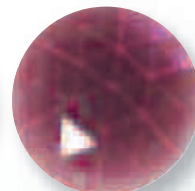

Ametisto

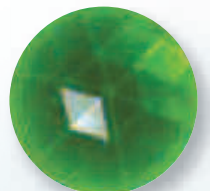

Verde

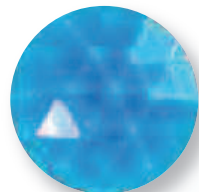

Acuamarino



Azul



Rojo

Nuestras joyas son fabricadas de vidrio vertido acabado a mano y facetado para crear un elemento de vidrio que brillará en cualquier diseño. Ofrecemos 6 opciones de colores además de la joya transparente.





Diseños de Vidrio Fundido

Para un aspecto más actual ahora podemos ofrecer diseños que incorporan la gama de azulejos de vidrio de Fusión RegaLead y de Fusión Ligera. Estos azulejos Fundidos se fabrican calentando lentamente dos o más piezas de vidrio en un horno hasta que empiecen a derretirse y entonces gradualmente enfriando el vidrio derretido de manera controlada para que las piezas se recocen y se fundan juntas.

CABFLITE 01



CABFLITE 02



CABFUS 06

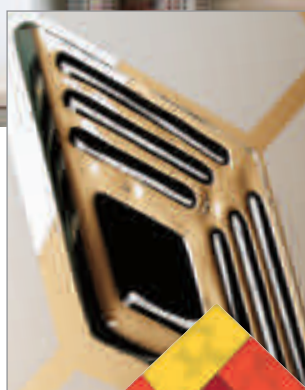

Fusión

Vidrio colorado fundible de 3 mm de Spectrum™

Vidrio transparente fundible de 3 mm de Spectrum™

Fusión Ligera

Vidrio colorado fundible de 3 mm de Spectrum™

Vidrio transparente fundible de 3 mm de Spectrum™

Ofrecemos 2 variedades distintas de diseños usando los azulejos de Fusión – los diseños de Fusión que se muestran en las páginas 48-49 son azulejos incorporados a diseños de vidrio grabado. Nuestra gama de diseños de Fusión Ligera en las páginas 50-51 combina azulejos de vidrio fundido, perfiles de plomo y películas coloradas y de Efecto de Textura.

Con nuestros diseños de fusión se puede escoger entre una variedad de combinaciones de colores con rojos, verdes y azules disponibles en todos los diseños de azulejos – negros y neutrales son posibles en algunos diseños.

La gama completa de azulejos de Fusión y colores disponibles se puede ver en el folleto de 28 páginas 'Arte de Fusión'.



Fusión

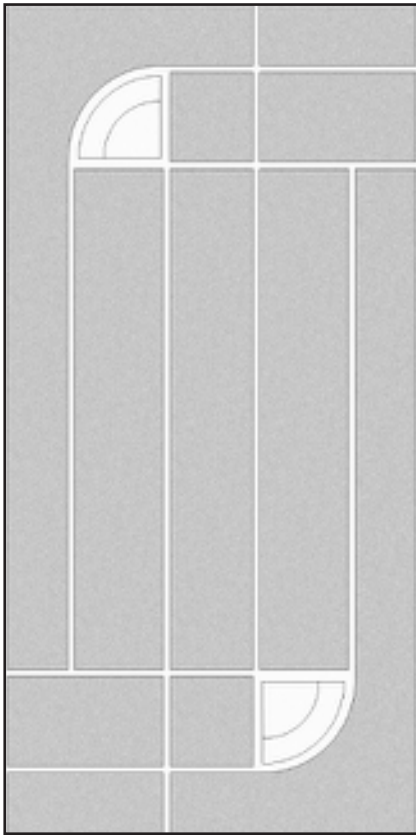

CABFUS 01

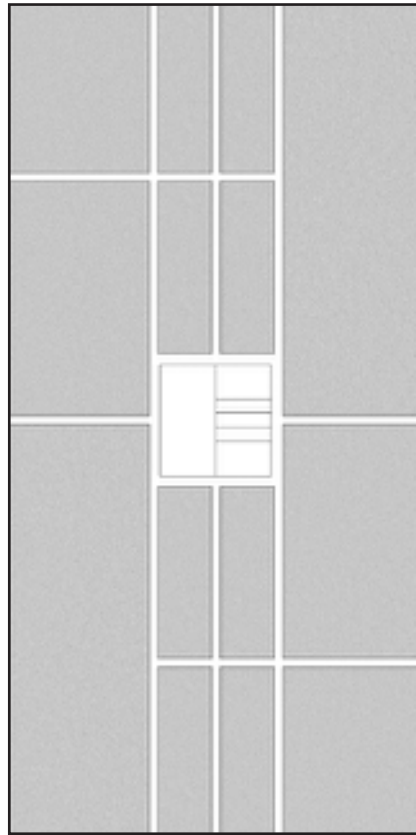

CABFUS 02

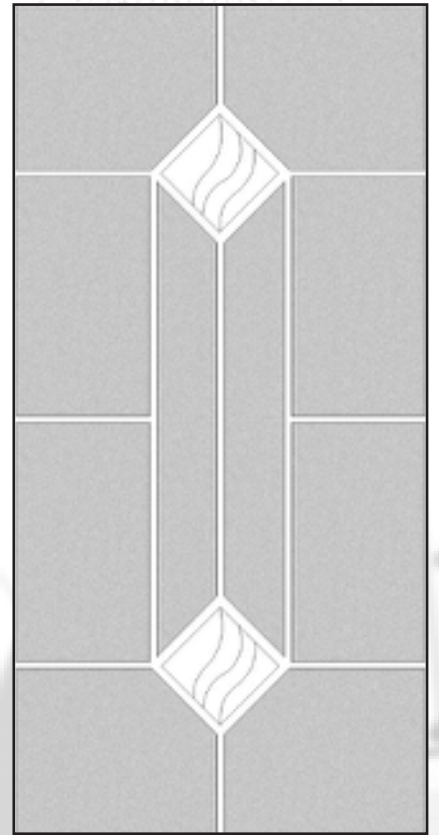

CABFUS 03

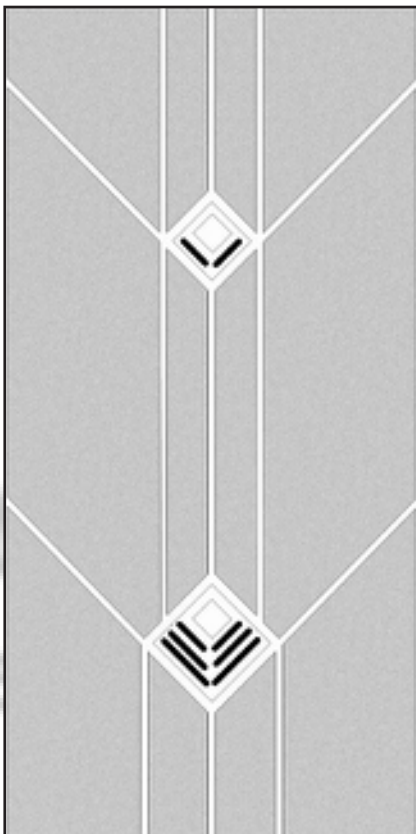

CABFUS 04

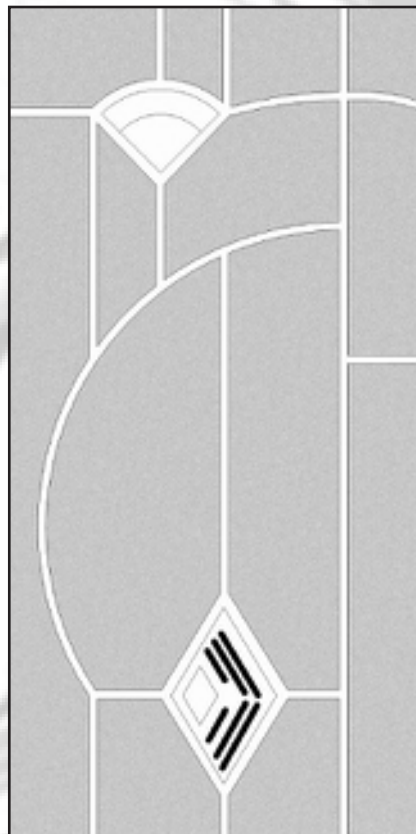

CABFUS 05

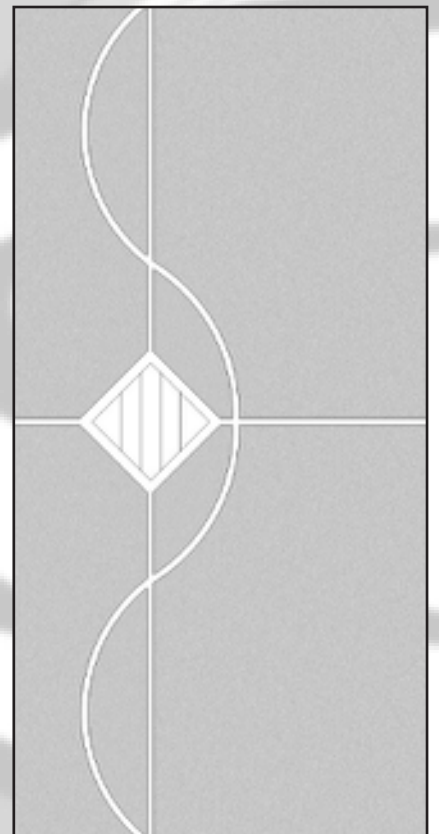

CABFUS 06

Fusión

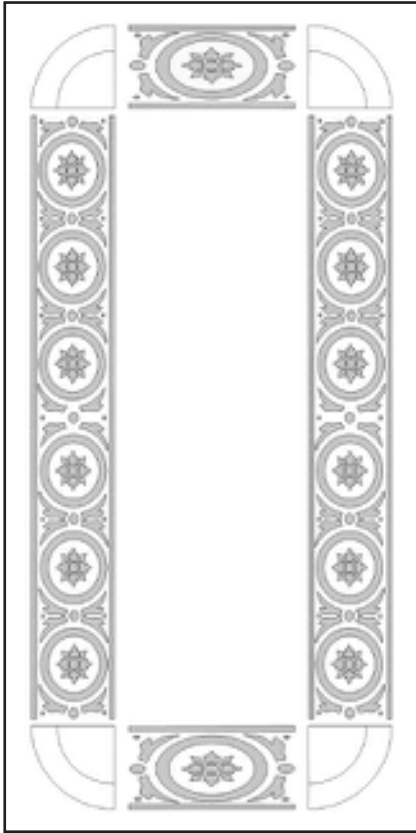

CABFUS 07

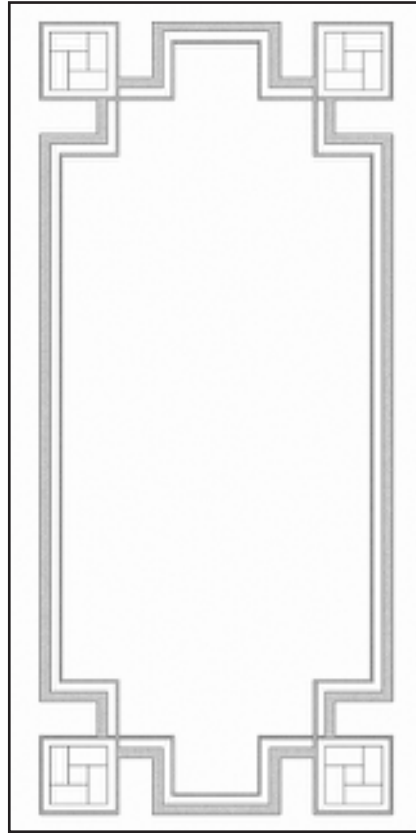

CABFUS 08

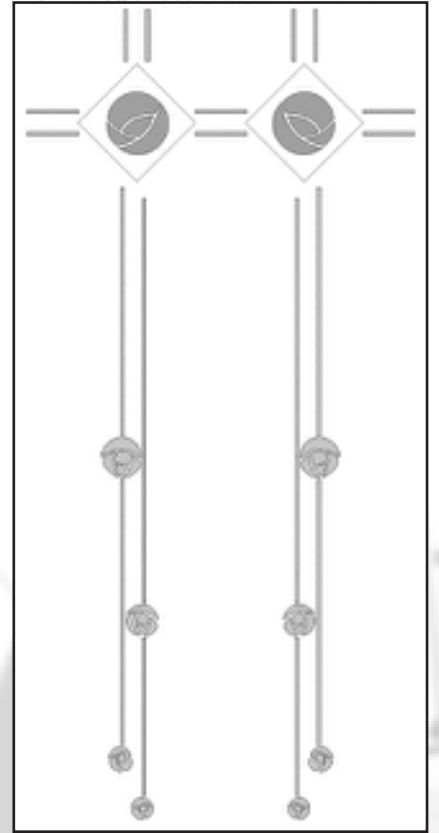

CABFUS 09

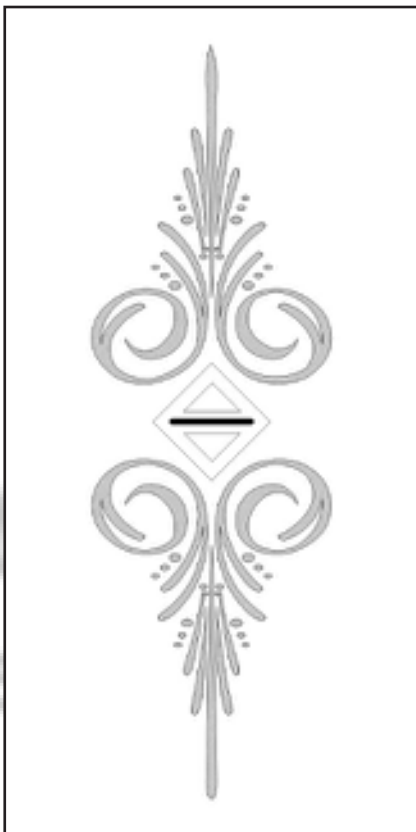

CABFUS 10

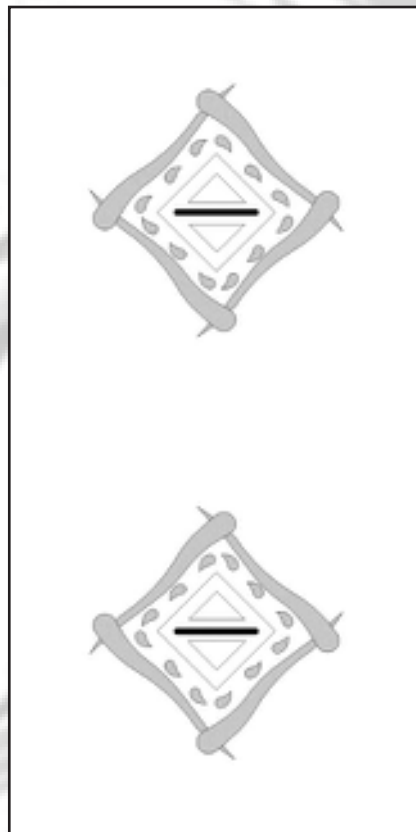

CABFUS 11

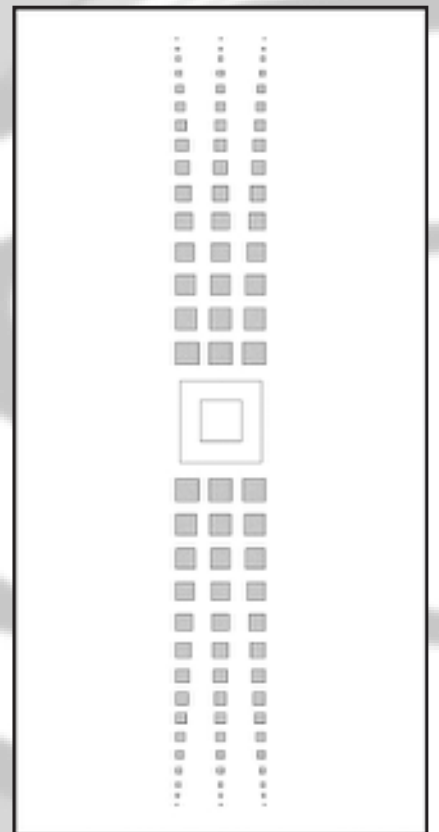

CABFUS 12

Fusión Ligera

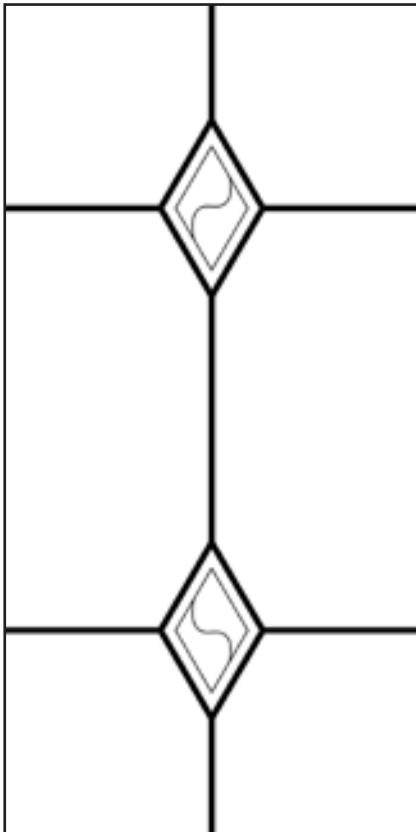

CABFLITE 01

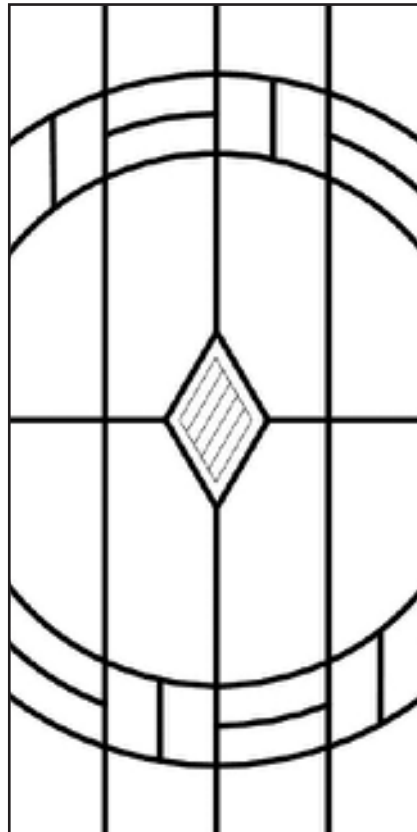

CABFLITE 02

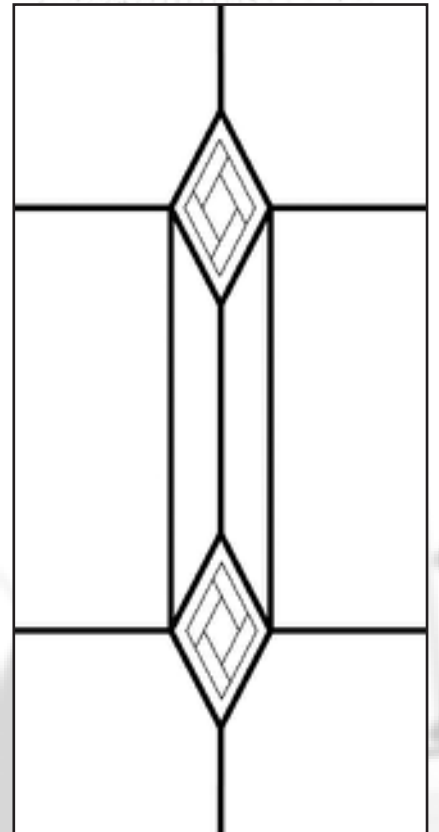

CABFLITE 03

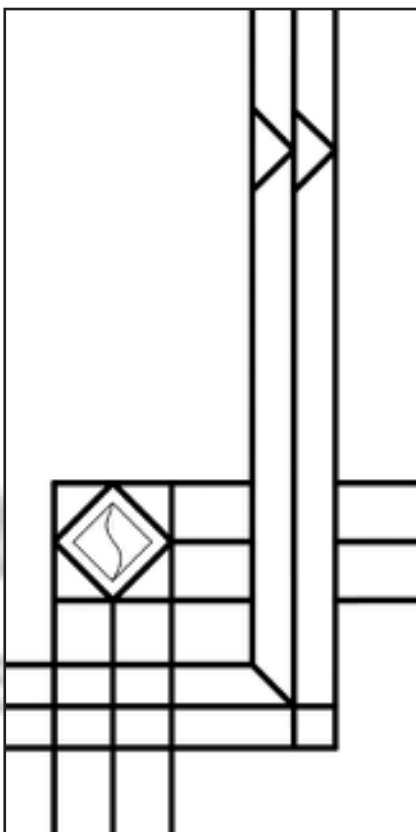

CABFLITE 04

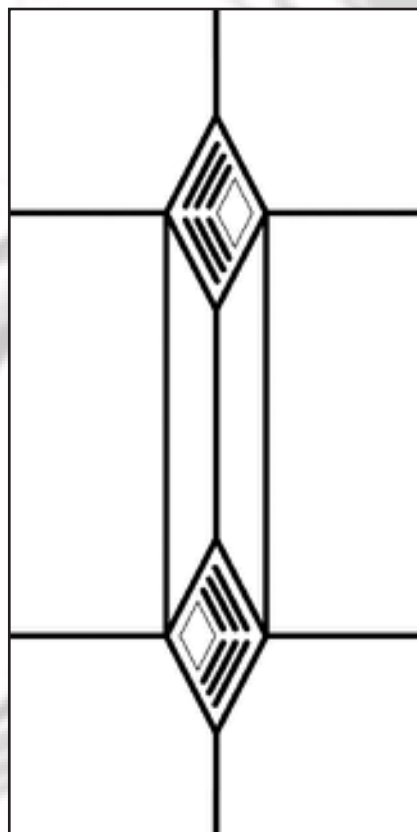

CABFLITE 05

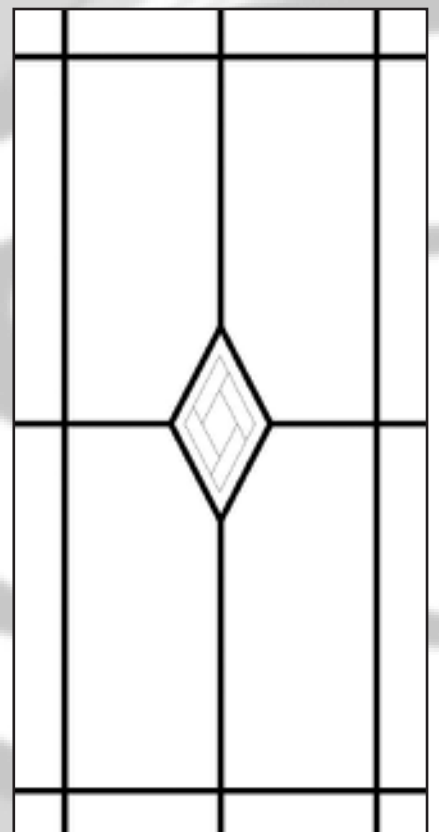

CABFLITE 06

Fusión Ligera

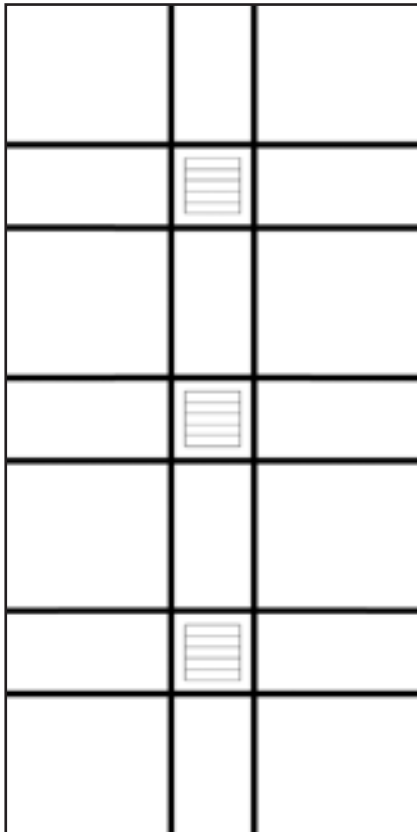

CABFLITE 07

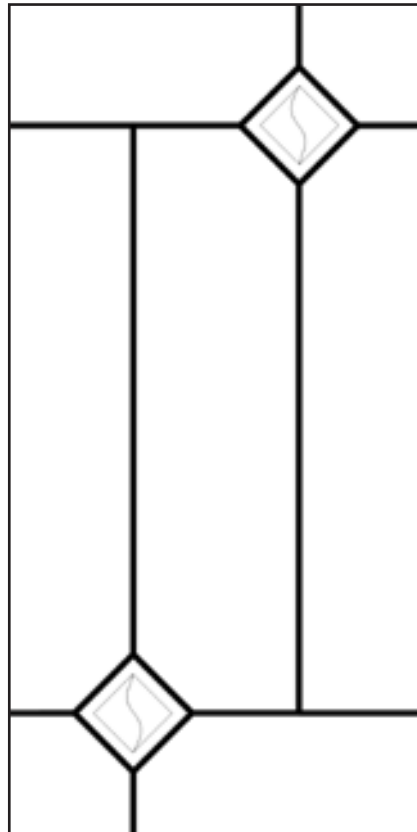

CABFLITE 08

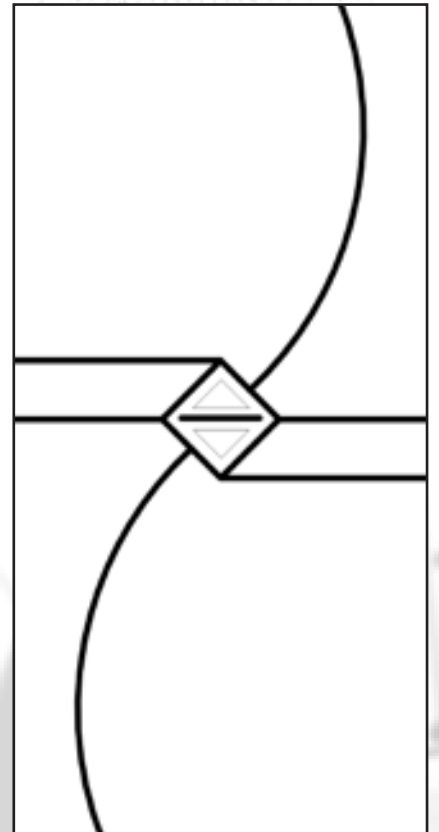

CABFLITE 09

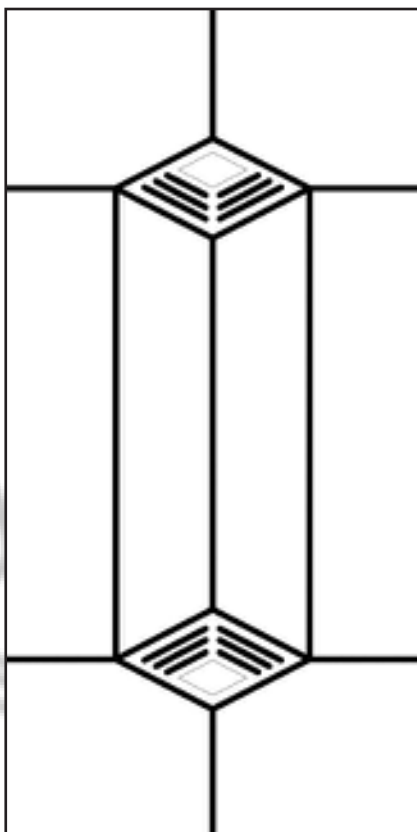

CABFLITE 10

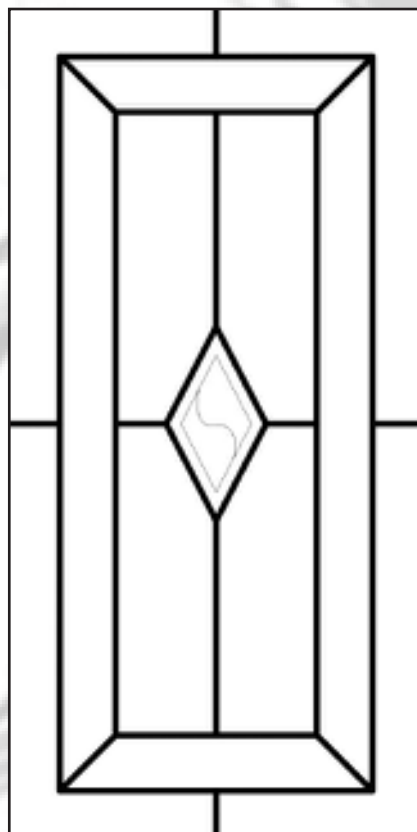

CABFLITE 11

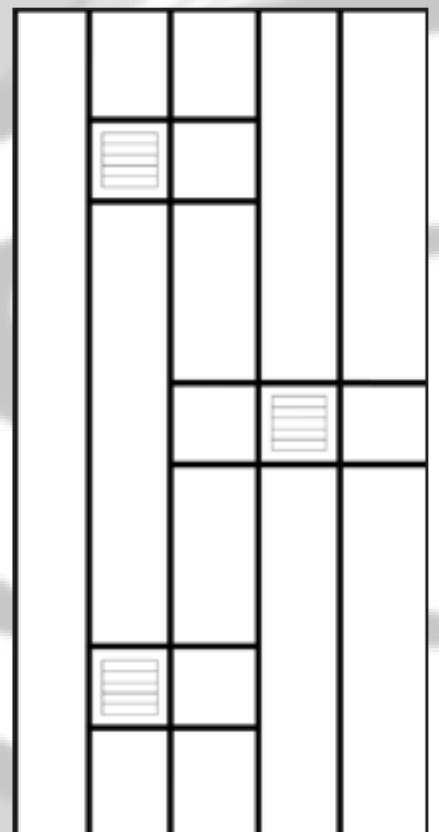

CABFLITE 12

Efectos de Textura de Vidrio



WAVERLEY **FCR662**



LINEN **FCR664**

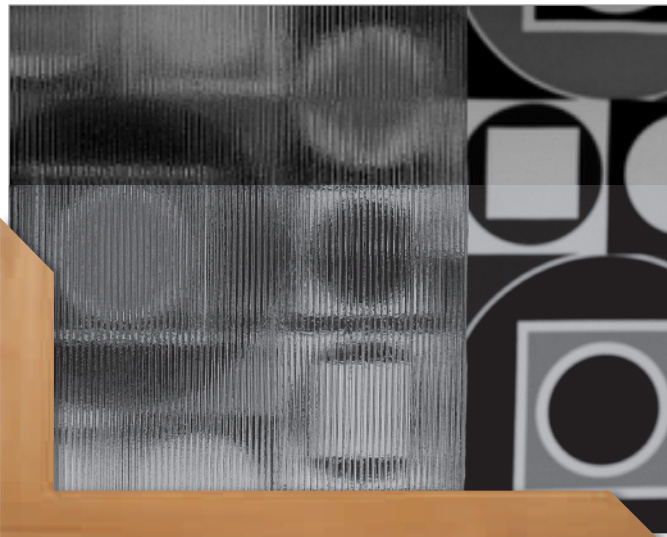

CORDUROY **FCR665**



BAROQUE **FCR668**

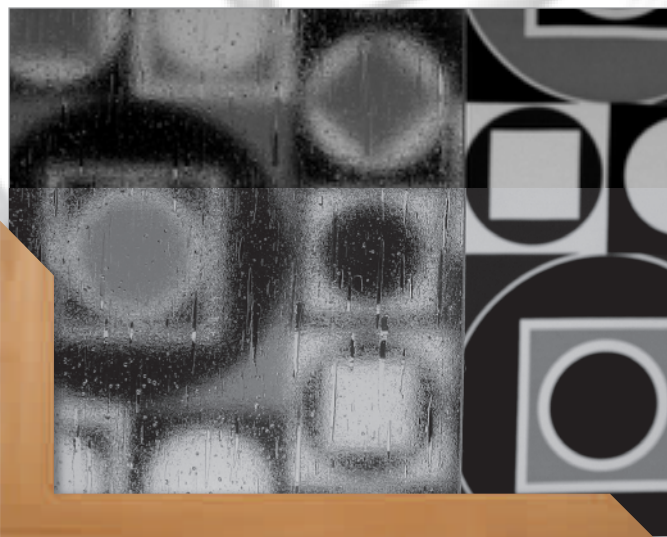

SEEDY **FCR671**

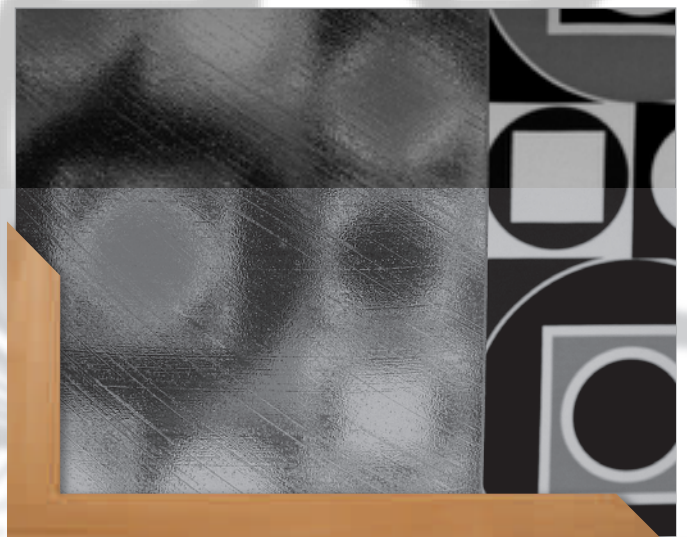

BRUSH OBSCURE **FCR677**

Efectos de Textura de Vidrio



CLEAR BRUSH **FCR678**

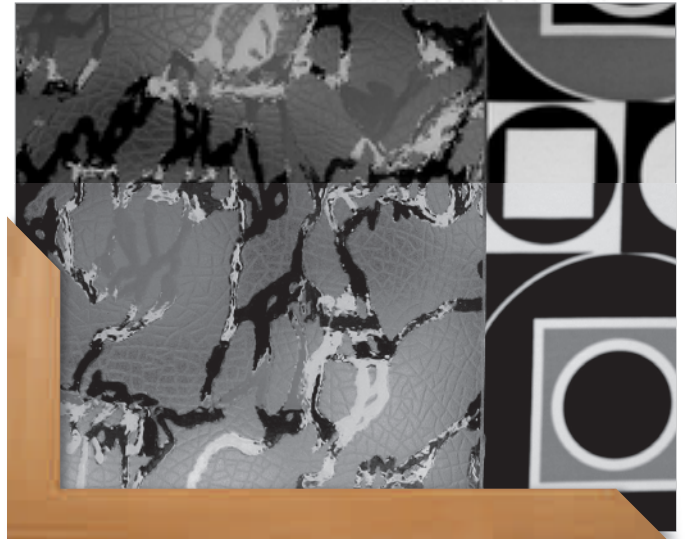

GHECKO **FTXCGK**



GLACIER **FTXGLA**



KRACKLE OBSCURE **FTXKRKLO**

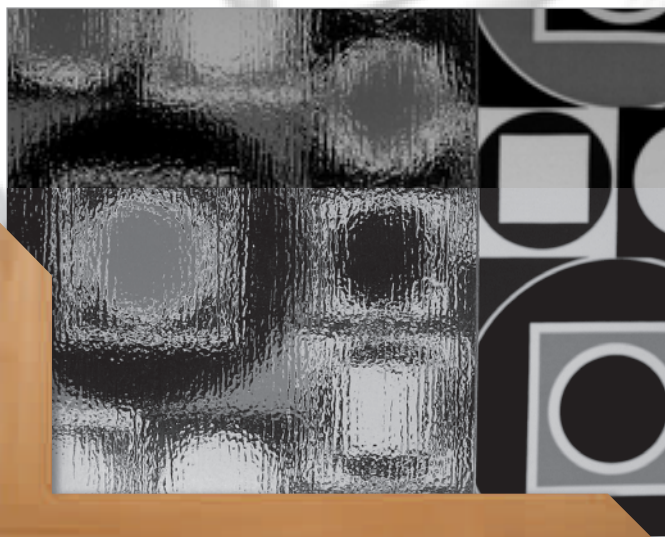

Especificaciones Técnicas, Limitaciones y Pautas de Instalación

Tamaños y Limitaciones

Todos los diseños en este catálogo se muestran en dimensiones de 305 x 610mm (12" x 24") pero se pueden cambiar de tamaño para adaptarse a la mayoría de los tamaños de vidrio para gabinetes con cambios mínimos a los diseños.

Secciones de Biselado y Fusión

En las secciones de biselado y fusión, las piezas de vidrio que se usan son de tamaño fijo y no se pueden cambiar.

Efectos de Textura de Vidrio

El tamaño máximo posible es de 450mm x 660mm (18" x 26"). Si la superficie de vidrio es superior a este tamaño, es posible dividir el diseño con líneas de plomo sencillas.

Especificaciones Materiales

Perfiles de Plomo

Nuestros perfiles de plomo se fabrican usando plomo puro al 99,5% modificado con antimonio y se aplican a la superficie de vidrio con un adhesivo acrílico sensible a la presión.

Los perfiles de plomo se ofrecen en acabado de plomo natural o con una variedad de superficies coloradas que incluye efectos de Blanco, Anticuario y Latón.

Todos los perfiles de plomo son disponibles en anchuras de 4.5mm (3/16"), 6mm(1/4") y 9mm(3/8"). En este folleto hemos usado la anchura de 4,5 mm en todos los diseños.

Biselados de Vidrio

Los biselados de vidrio mostrados en los diseños en las páginas 31 a 45 se fabrican de vidrio de 5 mm con un borde biselado, de costumbre de 12 mm (1/2"). Estos productos son hechos a mano y entonces pueden resultar algunas variaciones pequeñas de tamaño y anchura del biselado.

Como estas piezas de vidrio biselado son de tamaños fijos, no se puede cambiar los tamaños de los que se muestran en este catálogo.

Algunas de nuestras piezas y agrupaciones de biselados son disponibles en una variedad de colores de vidrio alternativos, incluso el azul, el verde, el bronce y el gris y también ofrecemos algunos artículos con una superficie dicróica o con piezas de pega. Por favor consulte el catálogo de la "Colección Definitiva RegaBevel" sobre la disponibilidad de productos.

Azulejos de Fusión

Los azulejos de vidrio fundido son hechos a mano usando el vidrio Spectrum™ proveniente de EE.UU. Ofrecemos la mayoría de los diseños de azulejos en una variedad de colores, incluso el rojo, el azul y el verde y algunos diseños son disponibles en negro, transparente y crema neutral. Por favor consulte el catálogo "Arte de Fusión" sobre la disponibilidad de productos.

Como los azulejos de Fusión son fabricados a mano y eso implica fundir dos o más estratos de vidrio juntos, es común que resulten algunas pequeñas inclusiones de aire dentro del vidrio. Es una característica del producto que añade dimensión y contraste al azulejo y no se debería ver como una falla.

Los azulejos de fusión son disponibles únicamente en tamaños fijos y no es posible cambiar los tamaños de los que se muestran en este catálogo.

Colores de SGO

Los colores y las texturas que se usan en nuestros diseños son películas de mylar impresas a mano con estabilidad excepcional ante la radiación ultravioleta. El tamaño máximo de una hoja es de 460 mm X 660 mm y por eso no se puede tener ninguna pieza de color o de textura individual más grande de este tamaño.

Con nuestras películas de efecto de color (FCA, FSV, FTV etc.) el patrón se aplica a mano y ningún par de hojas es igual, entonces las variaciones de patrón y densidad del color son una característica del producto y no se deberían considerar una falla.

Pautas de Instalación

Los selladores de silicona se usan frecuentemente para sellar las lastras de vidrio en los gabinetes. Desafortunadamente, los selladores de silicona más frecuentemente usados, el tipo acetóxico, que se puede reconocer por su olor "a vinagre", pueden causar corrosión de la superficie del perfil de plomo y también a los revestimientos en los perfiles de efecto Blanco, Latón y Anticuario. Para evitar este problema debe usar una silicona neutral que no cause corrosión, como el Dow Corning 796.

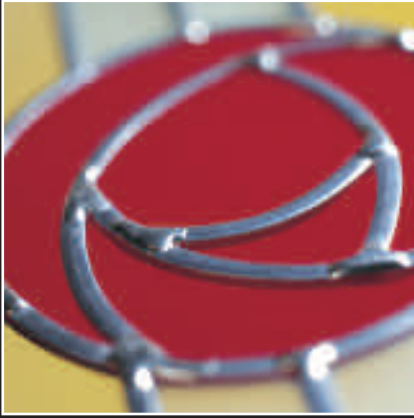

Vidrio Diseñado

Sede Empresarial de SGO
1827 North Case Street | Orange, CA 92865
1-800-944-4746
www.sgodesignerglass.com
info@stainedglassoverlay.com